



 COOLON

CASSIDY

200W LED Flood Light

Cassidy Flood Light has been specifically designed to provide ease of installation with high flexibility in optics selection and mounting position.

It is engineered for a very long life using highly resistive to corrosion LM6 alloy body, SS316 mounting bracket and a Low Iron tempered glass diffuser in combination with superb LED Driver and top of the range LEDs to address the most demanding applications.

Designed for use in:

- Area Lighting
- Billboards
- Drag Lines
- Exterior Walls
- Flood Lighting
- Security Lighting
- Workshops



Built to Last

Unlike conventional LED floodlights, the Cassidy was designed to withstand rough surface conditions.

- Resistant to Vibration
- Impact & Shock Proof
- Chemical Resistant
- High Pressure Washable
- Unaffected by Severe Temperature Variations

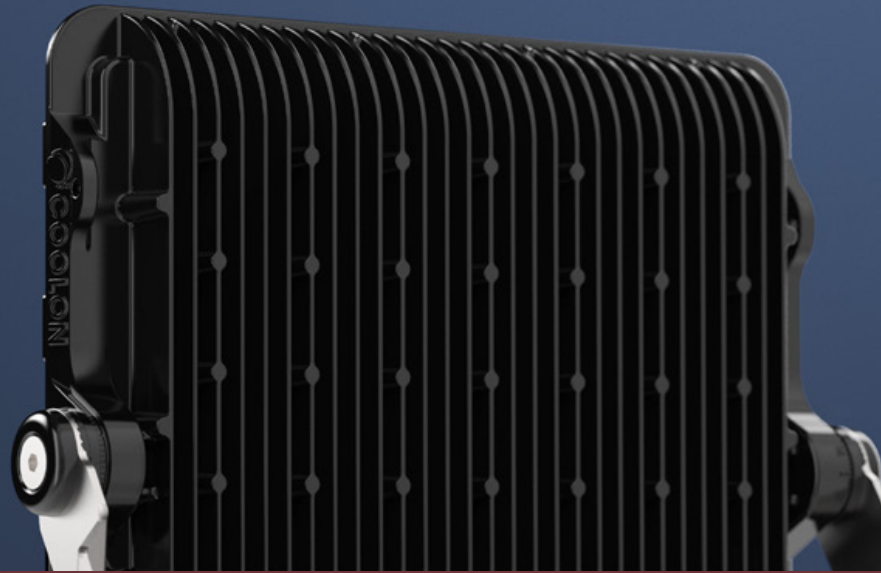

Optical Flexibility

The Cassidy is available in a wide range of optical variations offering the ability to maximise the effective performance in each particular application.

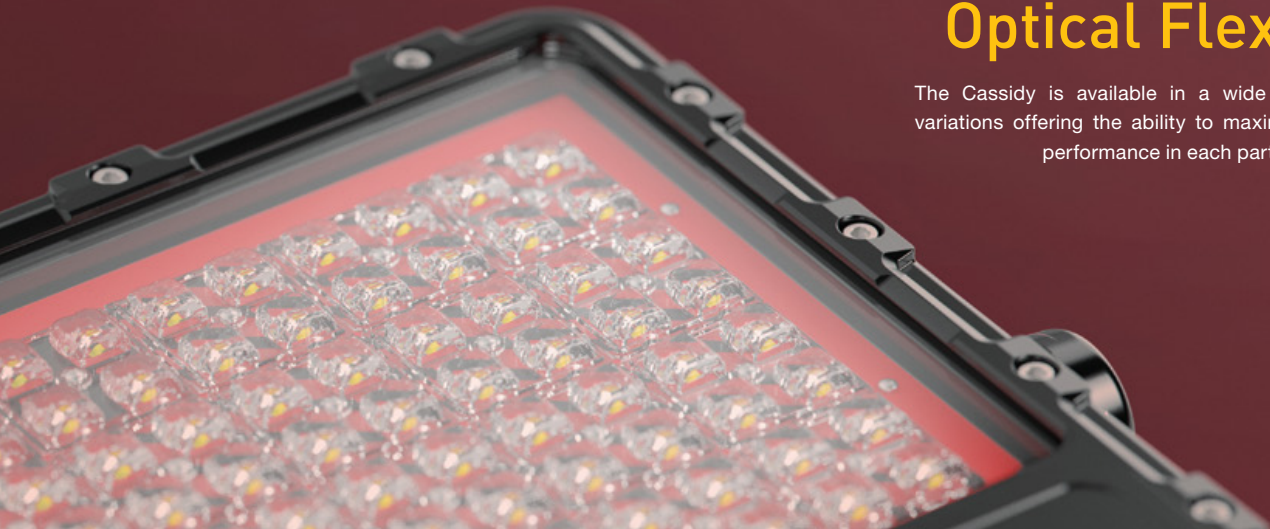

COOL SURFACE TEMPERATURE

Coolon's Industrial LED fittings have a much lower surface temperature than traditional HID equivalents which prevents dirt from baking onto the luminaire. This allows for easier cleaning and will prolong the lifespan of the luminaire.



NO FLICKERING

LED luminaires run on constant low voltage DC power and do not produce any visible stroboscopic effects, thus reducing the strain on eyes and significantly improving safety in areas where moving machinery is present.



UNRESTRICTED BURNING POSITION

Coolon's LED luminaires can be positioned and oriented in any desired way without affecting the lifespan of the product. This gives greater flexibility when it comes to aiming angles and orientation.



YEARS

3 YEARS FACTORY WARRANTY

Coolon Luminaires are covered by a solid comprehensible manufacturer's warranty that covers a range of possible defects and performance parameters throughout the duration of the warranty period.



INSTANT ON/OFF

LEDs do not require warm up. Instant on to 100% output translates to no downtime, improved safety and the ability to utilize sensor switching to significantly save energy.

IP66

HIGH IP RATING - IP66

Coolon's Industrial LEDs are designed specifically to withstand the harsh conditions in mining environments. The robust design allows our LED products to be used in many different applications and are high pressure washable.



INDUSTRIAL GRADE FINISHINGS

A long-life luminaire deserves a long-life finish. We source the finest alloys and surface treatments to ensure the luminaire provides superior performance all year round in all weather conditions.



PROUDLY MADE IN AUSTRALIA

Engineered to perfection, using only the highest quality components and highly skilled labour, each luminaire is assembled and thoroughly tested to ensure that it exceeds the highest standards.

DIMENSIONS

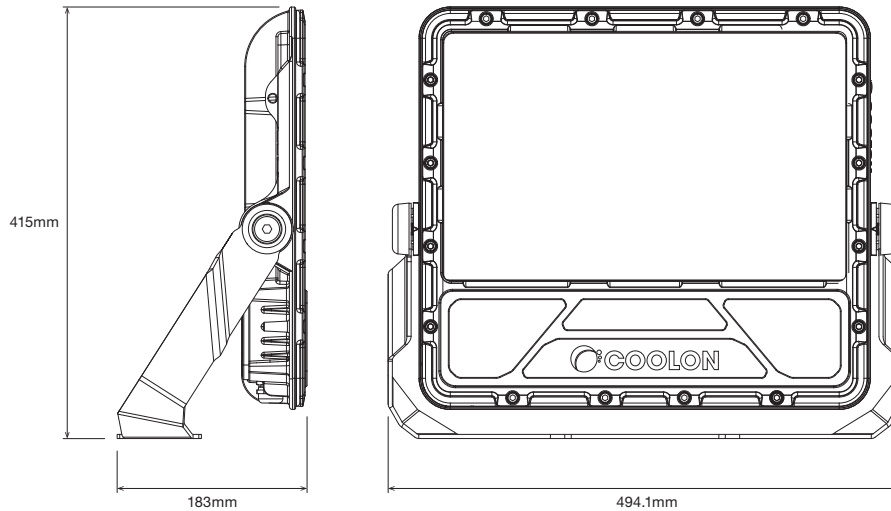

MOUNTING BRACKET

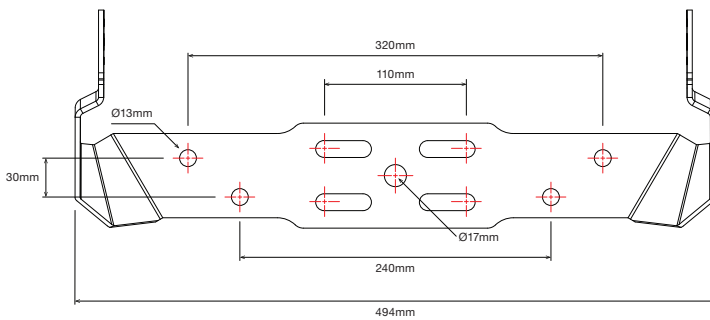

ACCESSORIES

Optional U-Bolt Pole Mounting Clamp Kit x 2
(available separately)
refer to industrial accessories brochure.
visit coolon.com.au to download now.

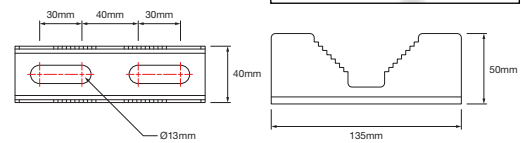

COLOUR TEMPERATURES

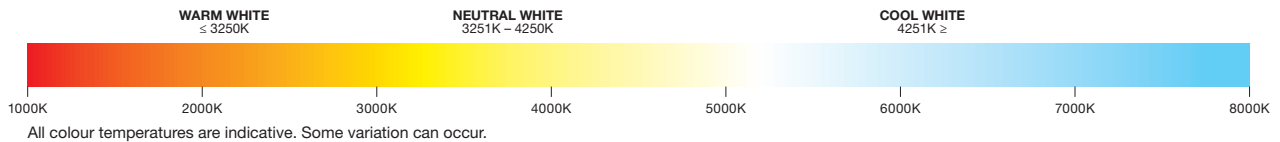

TECHNICAL SPECIFICATIONS

Product	Cassidy LED Flood Light
Model	CASS
Optical Characteristics	
Luminous Flux (Photometered)	19,121 – 21,816 lm
CCT	NWT / WWT
CRI	> 70
Electrical Characteristics (Luminaire)	
Power Consumption	200W
Nominal Voltage	230VAC
Voltage Range	90 - 277 VAC / 127 - 250VDC
Frequency Range	50 / 60Hz
Power Factor	> 0.95
Leakage Current	<0.70mA @ 240VAC / 60Hz

Environmental	
IP Rating	IP66
Impact Rating	IK08
Salt Spray Tested	Yes
Operating Temp. Range	-20 to 50°C
Thermal Management Type	Active/Continuous
Expected Lifespan	70,000 Hours to 70% Brightness
Material Composition (Body)	LM6 Aluminium Alloy
Material Composition (Optics)	PMMA
Material Composition (Terminal Cover)	PC 20% GF
Material Composition (Transparent Front)	Tempered Glass
Material Composition (Bracket)	Stainless Steel 316
Adjustment Angle	360° in 6° steps
Cable Entry Options	M20 Stainless steel cable gland
Cable Diameter	7 - 13mm

Weight/Packaging	
Luminaire Weight	12kg
Packaging Dimensions	580 x 500 x 160mm
Packaged Weight	15kg

Warranty	
Warranty	3 years warranty as standard up to 10 years extended warranty optional

² Reading taken while test unit operating in steady state. Ambient temperature during testing is typically 25°C. Individual unit behaviour may differ due to electronic component tolerance and ambient conditions. Product parameters and application suitability shall be checked by the user prior to commissioning.

ILLUMINANCE AT DISTANCE

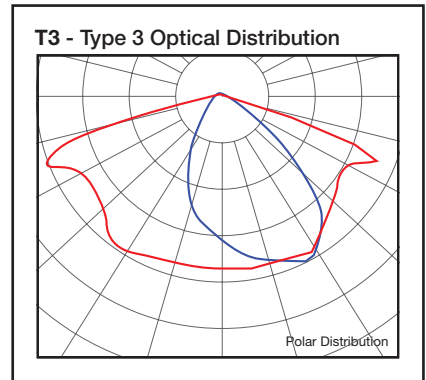
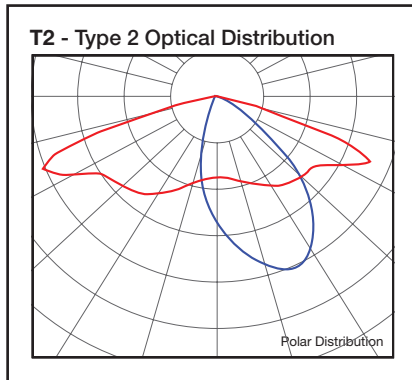
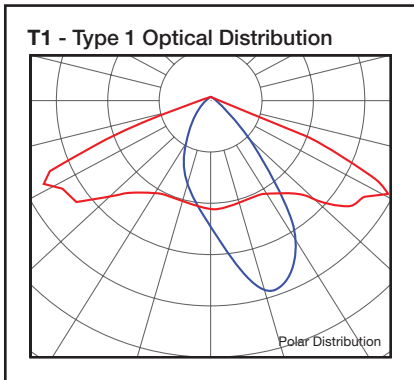
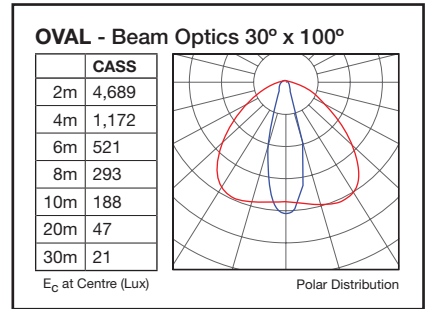
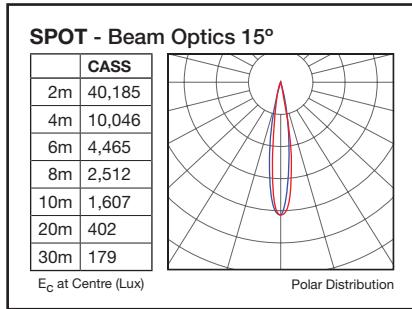
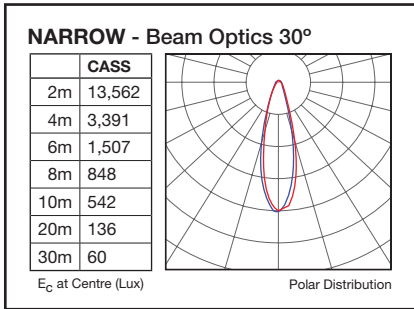
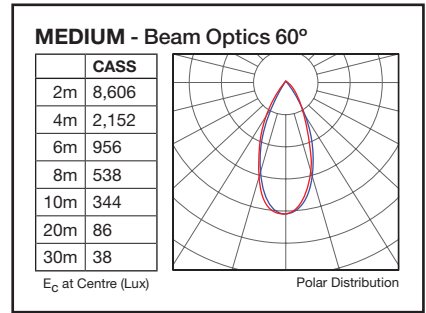
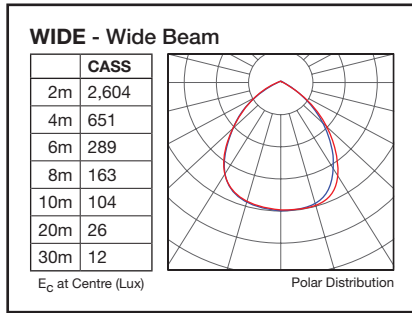
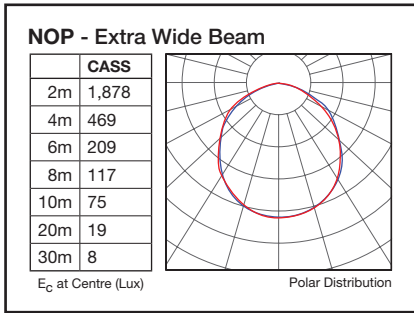

ISOLUX

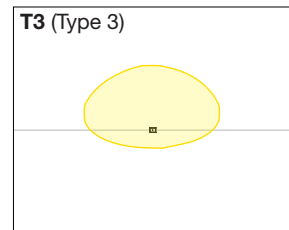
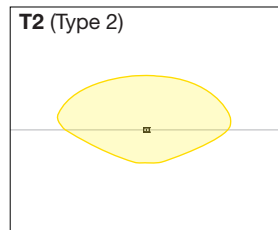
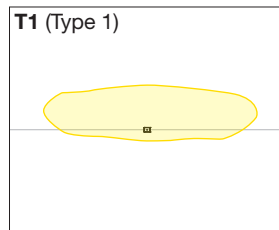
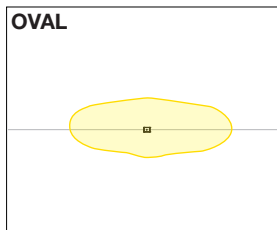

ORDERING EXAMPLE

CASS - NWT - NARROW - MP

PRODUCT COLOUR TEMPERATURE OPTICS SUPPLY OPTION

PRODUCT	COLOUR TEMPERATURE	OPTICS	SUPPLY
CASS	NWT Neutral White	NOP Extra Wide Optics	MP Mains Powered
	WWT Warm White	WIDE Wide Optics	
		MEDIUM Medium Optics	
		NARROW Narrow Optics	
		SPOT Spot Optics	
		OVAL Oval Optics	
		T1 Type 1 Optics	
		T2 Type 2 Optics	
		T3 Type 3 Optics	