

MC22 - Main Powered

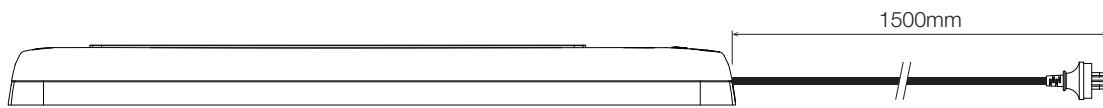
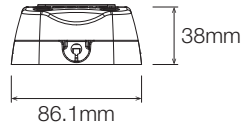
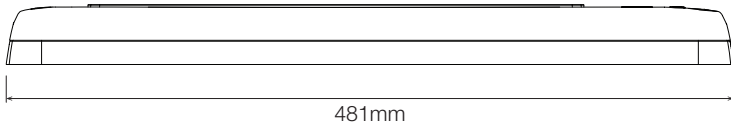
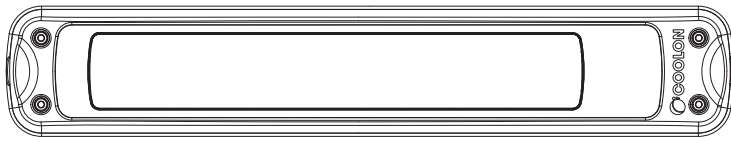

Electrical Characteristics
Voltage Range 180 – 255VAC
Power 20W @ 230VAC

INSTALLATION INSTRUCTIONS

Step 1

Remove the 4x socket head screws to separate the base and the main assembly.

Step 2

Secure base to the mounting surface.

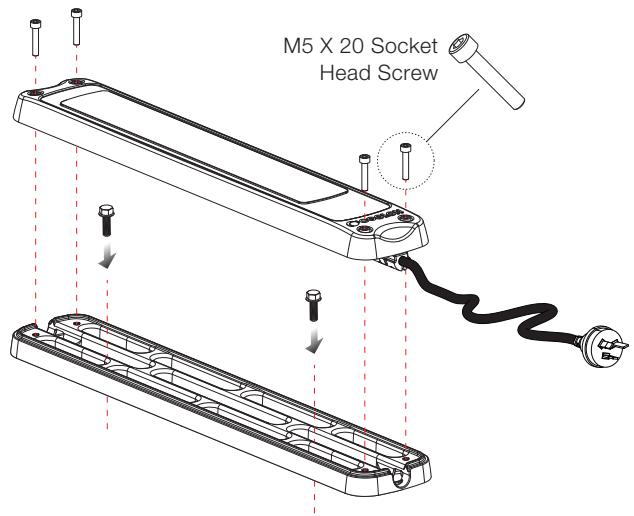
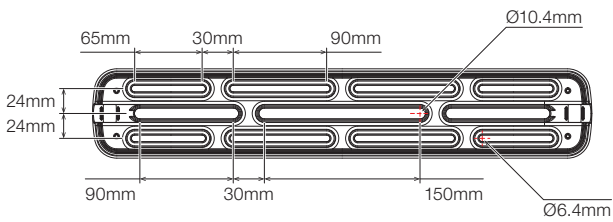

Step 3

Place main assembly onto the base and secure using 4x socket head screws from Step 1.

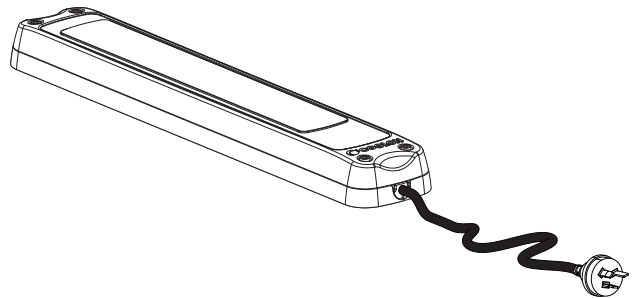

Step 4

Your MC22 is now ready to be connected!