

Emergency Power Pack (EMP)

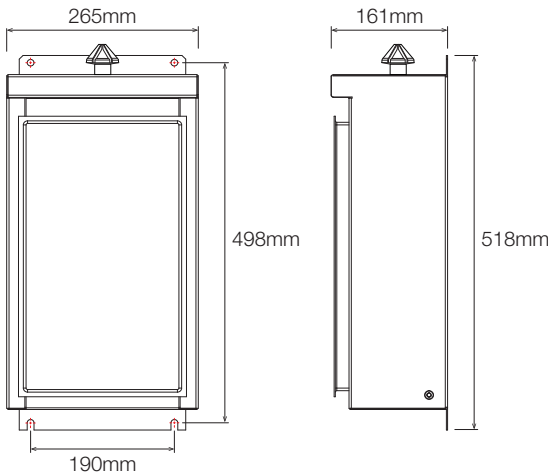

⚠ ATTENTION:
Isolate mains supply externally before conducting any work.

NOTE:
 Mains connection to either terminal will energise both terminals.

RISK OF SHOCK:
 During fault condition mains must be connected and the battery isolation switch must be in the ON position for the error indicators to be accurate.

| Electrical Characteristics | | |
|--|----------------------|-----------------------------|
| Voltage In 120 – 277 VAC, 50/60 Hz | Power 100W | Power Factor 0.95 |

⚠ ATTENTION:
EMP must be installed in the upright position

Pole Mounting Kits are available designed for mounting products on a variety of poles used in the industry.
 For more information visit: <http://www.coolon.com.au/ind-acc-pdf>

Installation Instructions

1. Mount the EML luminaire and EMP in suitable locations – ensure the EM cable from the luminaire can reach the EMP.
2. Connect the EM cable to the EMP.
3. The EM cable has a moulded connector for direct connection to the mating panel mount connector on the EMP.
4. Connect mains supply cable to the mains terminal – see connection options below for different modes of operation.

Emergency Pack Operating Modes

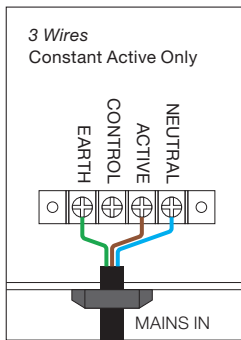

NON-MAINTAINED
 Emergency use only

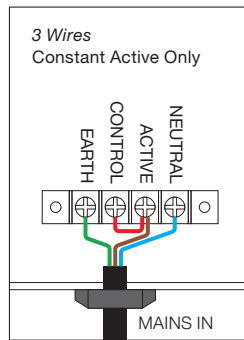

MAINTAINED
 Always ON

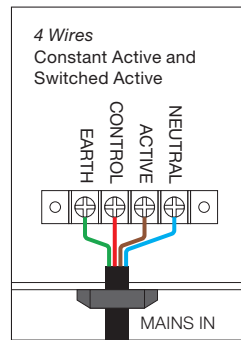

SWITCHED
 Conventional luminaire use with emergency backup

| OPERATION STATE | ACTIVE | CONTROL | LUMINAIRE STATE | DESCRIPTION |
|-----------------|--------|------------|-----------------|---|
| Non-Maintained | ON | N/A | OFF | Luminaire light OFF. Red LED indicator will indicate mains presence with Red Indicator LED ON. |
| Non-Maintained | OFF | N/A | ON-EM | Luminaire light ON in EM mode (power supplied from battery). Red LED indicator will not be visible. |
| Maintained | ON | ON (Link) | ON | Luminaire light ON. Red LED indicator will indicate mains presence with Red Indicator LED ON. |
| Maintained | OFF | OFF (Link) | ON-EM | Luminaire light ON in EM mode (power supplied from battery). Red LED indicator will not be visible. |
| Switched | ON | ON | ON | Luminaire light ON. Red LED indicator will indicate mains presence with Red Indicator LED ON. |
| Switched | ON | OFF | OFF | Luminaire light OFF. Red LED indicator will indicate mains presence with Red Indicator LED ON. |
| Switched | OFF | ON or OFF | ON-EM | Luminaire light ON in EM mode (power supplied from battery). Red LED indicator will not be visible. |

Battery Details

Unit only designed to operate using LEAD CRYSTAL® batteries. Recommended battery listed below. Contact Coolon for replacement batteries.

| MANUFACTURER | MODEL | CAPACITY |
|-----------------|------------|-----------------|
| Betta Batteries | 6-CNFJ-7.2 | 12V, 7.2Ah/20HR |

Emergency Pack Operation

- Once the EMP is connected to mains the Red Indicator LED on the lid will illuminate to indicate mains presence.
 - If the Indicator LED is flashing, check that the battery isolation switch is in the “ON” position.
 - If the battery isolation switch is in the “ON” position and the Red Indicator LED is still flashing, see the EMP TROUBLESHOOTING section for further details.
- Pressing the “TEST BUTTON” on the lid will disconnect the mains simulating a power outage. The Red Indicator LED will stop illuminating and the EMP will operate in emergency mode if the battery isolation switch is in the “ON” position.
- Critical system fault is indicated by the flashing Red Indicator LED during mains voltage presence. See the EMP TROUBLESHOOTING section for further details.

Commissioning Test

Once energised allow up to 10 seconds for the EMP controller to go through the self-test procedure.

Batteries are labeled with their last charge date. If the batteries have not been used more than 3 months, they have to cycle 2–3 times to restore their capacity.

A typical cycle includes a 16 hour charge followed by a complete discharge.

Properly operating batteries operate Coolon Emergency Pack Luminaires for a minimum of 2 hours in the absence of mains power.

Emergency Pack Troubleshooting

On-board processor monitors the state of the EMP modules and periodically checks the batteries. Internal operations and fault conditions are signaled by on-board LEDs. Critical Fault will cause external Indicator LED to flash.

- Error Code ■ **RED LEDs (Internal Fault Indicator)**
Internal RED Fault indicator LEDs used for internal diagnostics. LEDs indicate internal faults using binary codes.
- Error Code ■ In the event external Indicator LED is flashing, information about the internal LED status may help diagnostic and fault rectification on-site. Contact COOLON support (support@coolon.com.au) for guidance.
- Charger 2 ■ **GREEN LEDs (Operating Mode Indicator)**
MAINS VOLTAGE LED will illuminate when mains is present.
- Charger 1 ■ CHARGER 1 and CHARGER 2 LEDs flash during charge and stay ON once the individual respective batteries are fully charged.
- Mains Voltage ■

Battery Replacement Procedure

- Isolate mains supply to the EMP.
- Put isolation switch to “OFF” position.
- Disconnect the spade terminals from the batteries.

NOTE: Do not use any conductive material to remove the terminal connector.
- Loosen the top then the bottom battery housing keeping the captive screws within the housings.
- Remove the batteries and insert new batteries.

NOTE: Fit the rubber battery tray to the new batteries before installation. The spade terminals connector must fit snug on the terminal – if the terminal connection is loose compress the connector slightly to ensure a sturdy connection.
- Tighten the bottom then the top battery housing. The batteries should sit snug with the battery housing flat on the base.
- Carefully connect respective spade terminals observing battery polarity.

NOTE: Black wire always connects to negative terminal of the battery.

Battery wiring diagram is provided on the right

Battery Dimensions

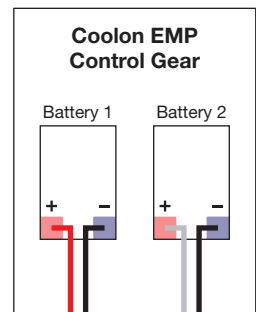
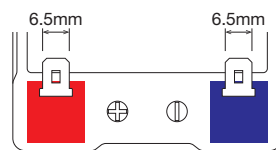
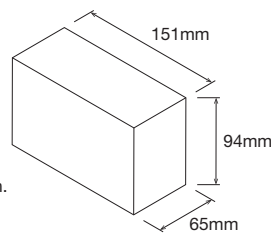

⚠ CAUTION

- Do not short circuit the battery terminals
- Dispose of the used batteries in accordance to State Law