



 COOLON

CASSIDY

240W LED Flood Light

Unrivalled perimeter coverage with top quality intense light

Engineered for a very long life using highly resistive to corrosion LM6 alloy body, SS316 mounting bracket and a low iron tempered glass diffuser in combination with superb LED Driver and top of the range LEDs to address the most demanding applications.

Cassidy has been specifically designed to provide ease of installation with high flexibility in optics selection and mounting position.

Designed for use in:

- Area Lighting
- Draglines
- Stacker / Reclaimers
- Flood Lighting
- Security Lighting
- Workshops
- Billboards



Built to Last

Unlike conventional LED floodlights, the Cassidy was designed to withstand rough surface conditions.

- Resistant to Vibration
- Impact & Shock Proof
- Chemical Resistant
- High Pressure Washable
- Unaffected by Severe Temperature Variations

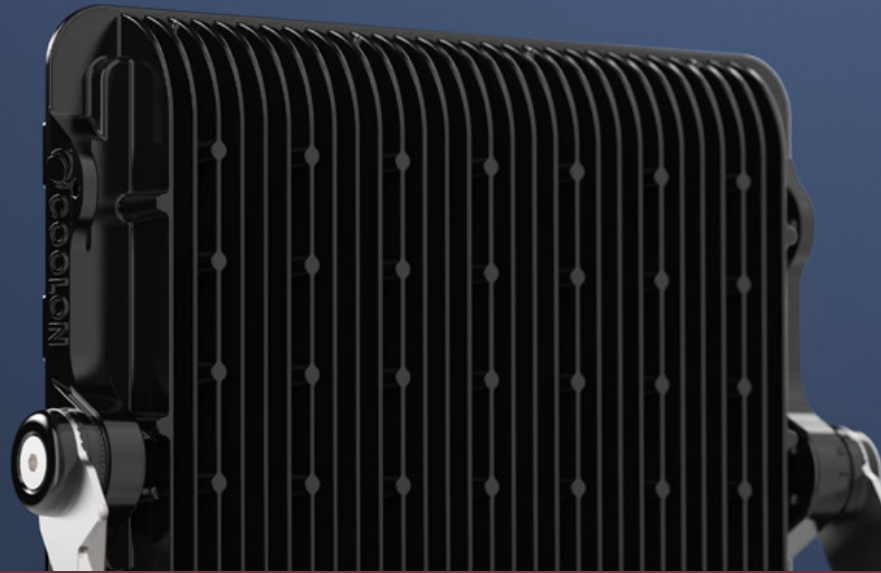

Optical Flexibility

The Cassidy is available in a wide range of optical variations offering the ability to maximise the effective performance in each particular application.

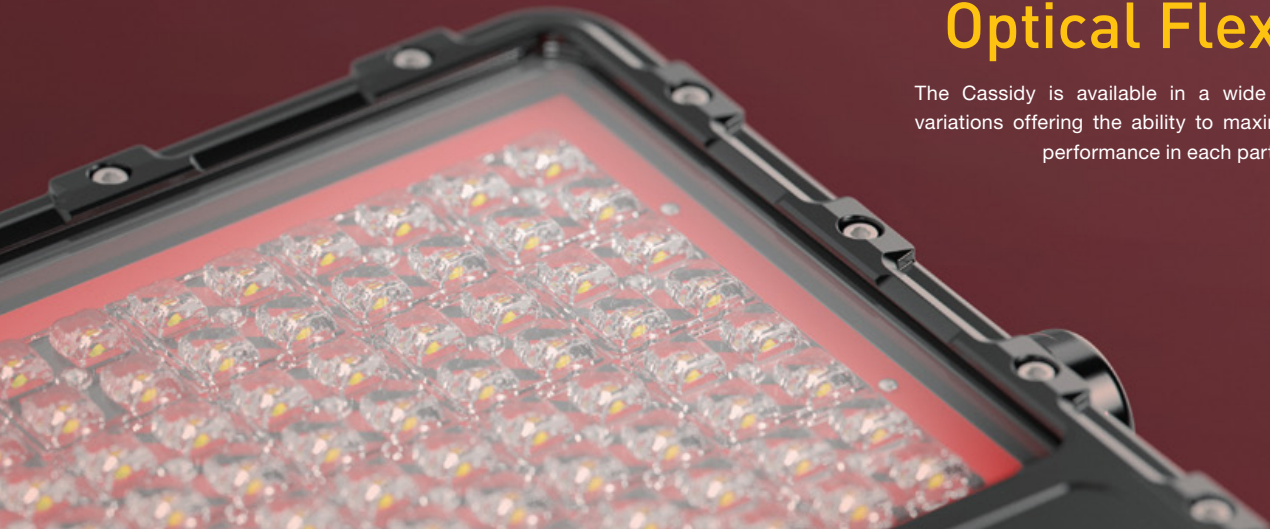

COOL SURFACE TEMPERATURE

Coolon's Industrial LED fittings have a much lower surface temperature than traditional HID equivalents which prevents dirt from baking onto the luminaire. This allows for easier cleaning and will prolong the lifespan of the luminaire.



NO FLICKERING

LED luminaires run on constant low voltage DC power and do not produce any visible stroboscopic effects, thus reducing the strain on eyes and significantly improving safety in areas where moving machinery is present.



UNRESTRICTED BURNING POSITION

Coolon's LED luminaires can be positioned and oriented in any desired way without affecting the lifespan of the product. This gives greater flexibility when it comes to aiming angles and orientation.



3 YEARS FACTORY WARRANTY

Coolon Luminaires are covered by a solid comprehensible manufacturer's warranty that covers a range of possible defects and performance parameters throughout the duration of the warranty period.



INSTANT ON/OFF

LEDs do not require warm up. Instant on to 100% output translates to no downtime, improved safety and the ability to utilize sensor switching to significantly save energy.



HIGH IP RATING - IP66

Coolon's Industrial LEDs are designed specifically to withstand the harsh conditions in mining environments. The robust design allows our LED products to be used in many different applications and are high pressure washable.



INDUSTRIAL GRADE FINISHINGS

A long-life luminaire deserves a long-life finish. We source the finest alloys and surface treatments to ensure the luminaire provides superior performance all year round in all weather conditions.



PROUDLY MADE IN AUSTRALIA

Engineered to perfection, using only the highest quality components and highly skilled labour, each luminaire is assembled and thoroughly tested to ensure that it exceeds the highest standards.

DIMENSIONS

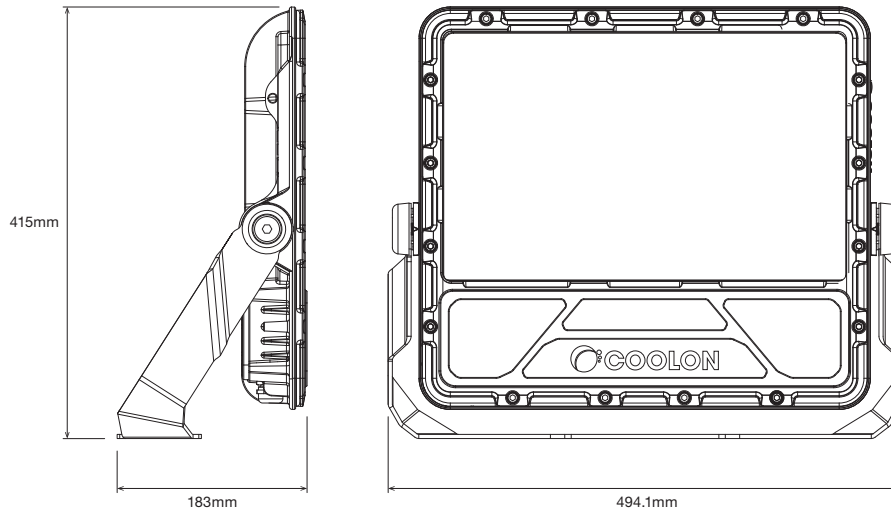

MOUNTING BRACKET

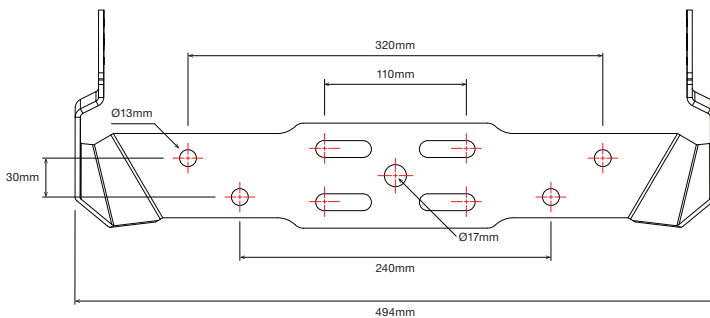

ACCESSORIES

Optional U-Bolt Pole Mounting Clamp Kit x 2
(available separately)
refer to industrial accessories brochure.
visit coolon.com.au to download now.

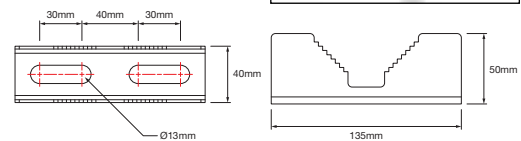

COLOUR TEMPERATURES

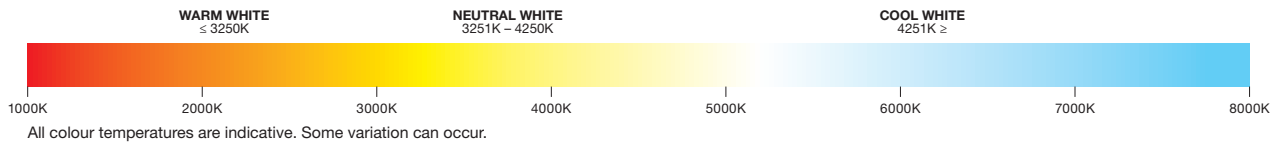

TECHNICAL SPECIFICATIONS

| | |
|---|--------------------------------|
| Product | Cassidy LED Flood Light |
| Model | CASS |
| Optical Characteristics | |
| Luminous Flux (Photometered) | 27,000 – 28,000 lm |
| CCT | NWT / WWT |
| CRI | > 70 |
| Electrical Characteristics (Luminaire) | |
| Power Consumption | 255W |
| Nominal Voltage | 230VAC |
| Voltage Range | 90 – 277 VAC / 127 – 250VDC |
| Frequency Range | 47 – 60Hz |
| Power Factor | >0.96 @ 230VAC |
| Leakage Current | <0.70mA @ 240VAC / 60Hz |
| Surge Protection | 6kV line-line, 10kV line-earth |

| | |
|--|---------------------------------|
| Environmental | |
| IP Rating | IP66 |
| Impact Rating | IK08 |
| Salt Spray Tested | Yes |
| Operating Temp. Range | -20 to 50°C |
| Thermal Management Type | Active/Continuous |
| Expected Lifespan | 70,000 Hours to 70% Brightness |
| Material Composition (Body) | LM6 Aluminium Alloy |
| Material Composition (Optics) | PMMA |
| Material Composition (Terminal Cover) | PC 20% GF |
| Material Composition (Transparent Front) | Tempered Glass |
| Material Composition (Bracket) | Stainless Steel 316 |
| Adjustment Angle | 360° in 6° steps |
| Cable Entry Options | M20 Stainless steel cable gland |
| Cable Diameter | 7 - 13mm |

| | |
|-------------------------|-------------------|
| Weight/Packaging | |
| Luminaire Weight | 12kg |
| Packaging Dimensions | 580 x 500 x 160mm |
| Packaged Weight | 15kg |

| | |
|-----------------|--|
| Warranty | |
| Warranty | 3 years warranty as standard 5 years extended warranty optional |

¹ Optical and electrical characteristics are measured using Neutral White LEDs (NWT)

² Reading taken while test unit operating in steady state. Ambient temperature during testing is typically 25°C. Individual unit behaviour may differ due to electronic component tolerance and ambient conditions. Product parameters and application suitability shall be checked by the user prior to commissioning.

ILLUMINANCE AT DISTANCE

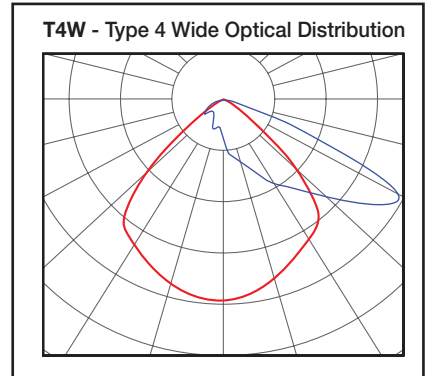
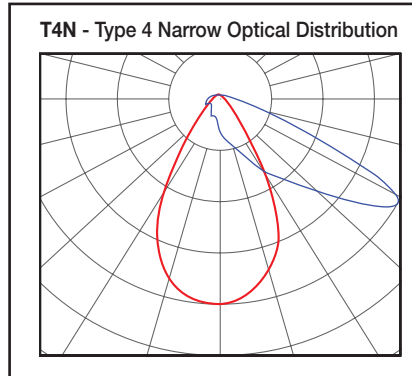
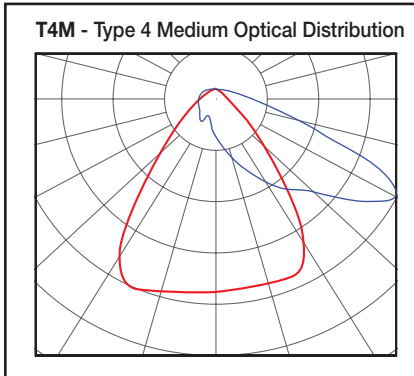
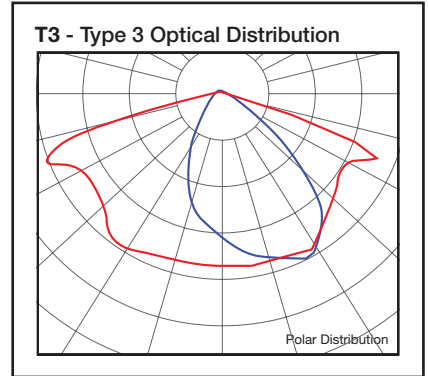
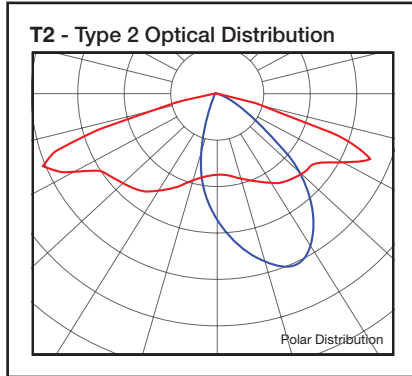
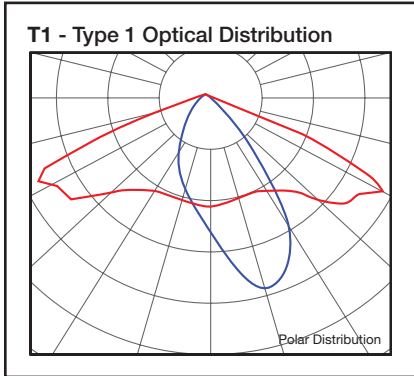
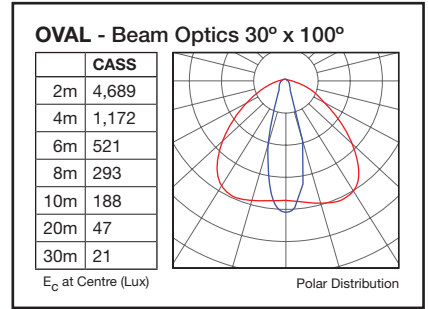
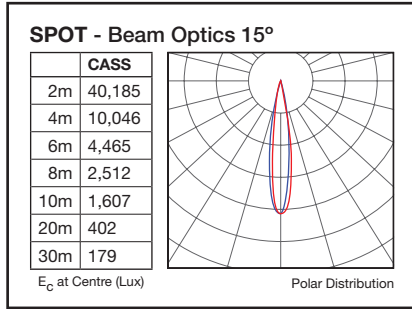
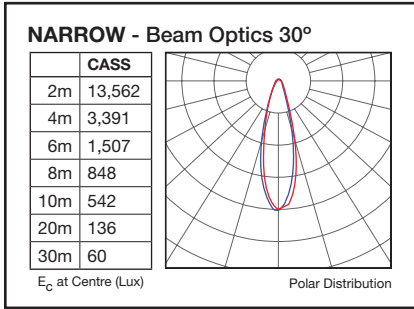
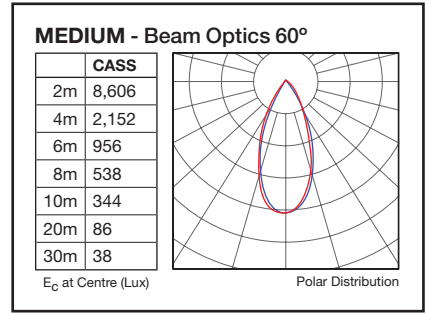
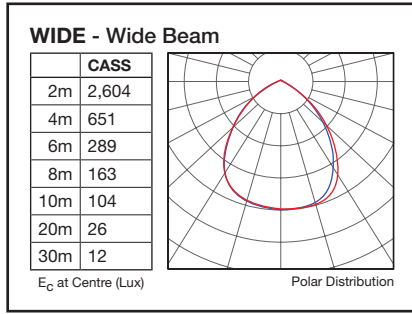
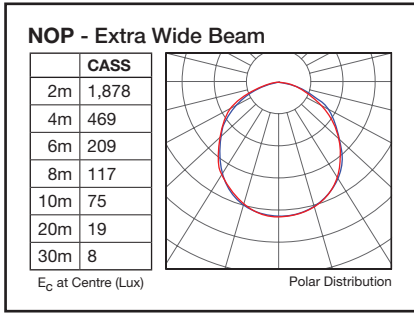

ORDERING EXAMPLE

CASS - 240 - NWT - NARROW - MP

PRODUCT TYPE COLOUR TEMPERATURE OPTICS SUPPLY OPTION

| PRODUCT | TYPE | COLOUR TEMPERATURE | | OPTICS | SUPPLY |
|---------|------------------|--------------------|---------------|--------|----------------------|
| CASS | 240 240W Version | NWT | Neutral White | NOP | Extra Wide Optics |
| | | WWT | Warm White | WIDE | Wide Optics |
| | | | | MEDIUM | Medium Optics |
| | | | | NARROW | Narrow Optics |
| | | | | SPOT | Spot Optics |
| | | | | OVAL | Oval Optics |
| | | | | T1 | Type 1 Optics |
| | | | | T2 | Type 2 Optics |
| | | | | T3 | Type 3 Optics |
| | | | | T4M | Type 4 Medium Optics |
| | | | | T4N | Type 4 Narrow Optics |
| | | | | T4W | Type 4 Wide Optics |