



# CC STRIP PROFILE INSTALLATION INSTRUCTIONS



## ▪ DIMENSIONS WITH MOUNTING TAPE

CC Profile

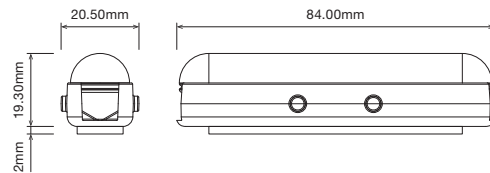

## ▪ DIMENSIONS WITH MOUNTING CLIP

CC Profile

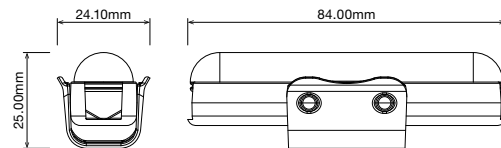

## ▪ WIRING OPTIONS

2 wires (RB) – Indoor only.

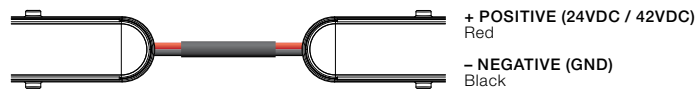

3 wires (RBW) – Indoor only.

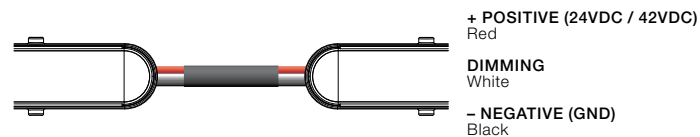

## ⚠ ATTENTION

- Please observe / follow the instructions methodically.
- Please ensure the units are handled with extreme care.
- Do not remove LED strips from packaging prematurely. Only remove from packaging when ready for installation.
- Failure to observe installation instructions and handling will void warranty of the product.

▪ STEP 1

Before you begin installation, ensure that you understand the fitting layout required as supplied fitting lengths may vary. Refer to the supplied cut sheet for length breakdowns.

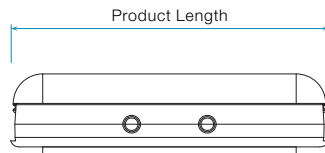

▪ WIRING

Wire the fitting to the correct power supply as advised on the cut sheet.

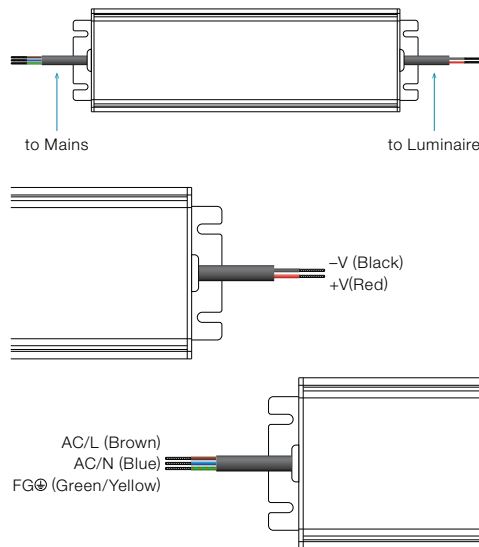

MOUNTING TAPE

▪ STEP 2

Prepare the mounting surface by wiping with alcohol to remove any dust or residue.

Peel a tape tab off the backing sheet and place sticky side down onto the mounting surface. Press the tab firmly in place to secure strongly and remove any air bubbles. Continue with the remaining tabs allowing spacings of 90mm between each.

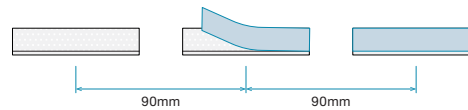

▪ STEP 3

Carefully peel the backing off the remaining exposed side of the tape tab to reveal the tacky surface. Press the back of the first segment onto the tab firmly to adhere in place. Continue with the remaining segments. Ensure you are working quickly with clean hands to prevent dirt and other substances contaminating the adhesive surface.

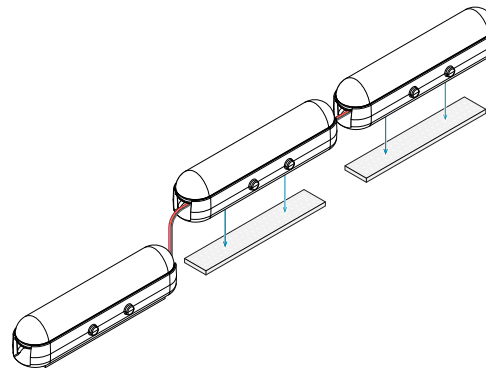

MOUNTING CLIPS

▪ STEP 2

Prepare mounting clips and screws (Ø3mm with a minimum length of 12mm).

Measure out the spacing between each mounting clip, spacing for CC is 90mm.

Secure clips with screws on timber or metal surface ensuring that mounting clips are straight.

*\*Mounting clips may be mounted using tape instead of screws*

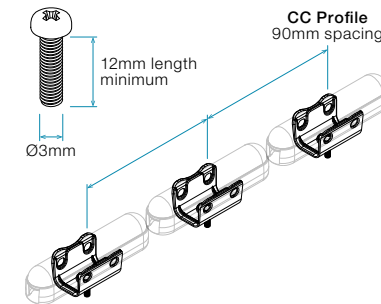

▪ STEP 3

Tilt LED segment on one edge and secure the other edge by latching to mounting clips.

Slide profile until the circular tabs align with the holes in the clip to lock into place.

