

FORMA

LED STRIP STR-FORMA

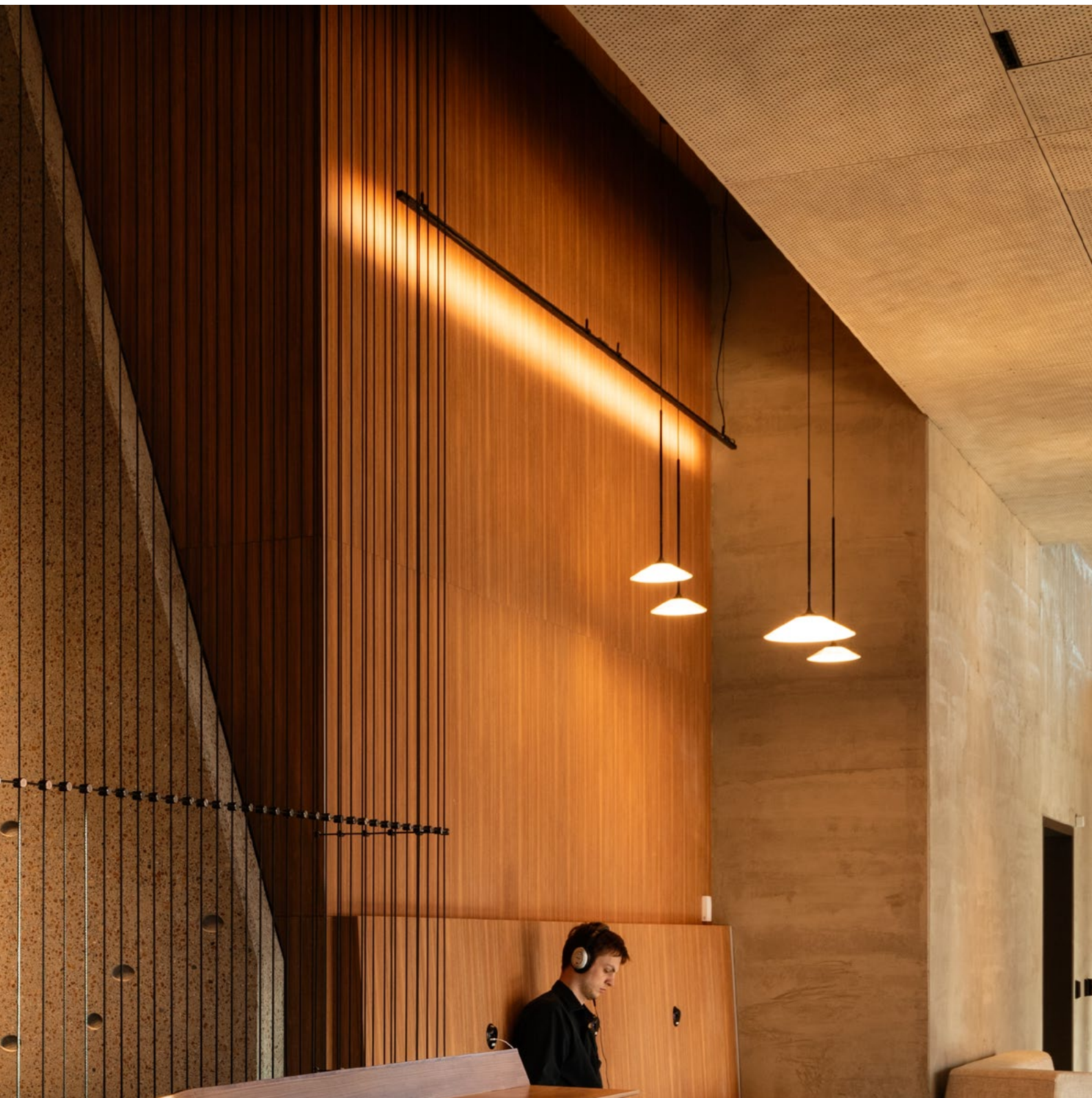

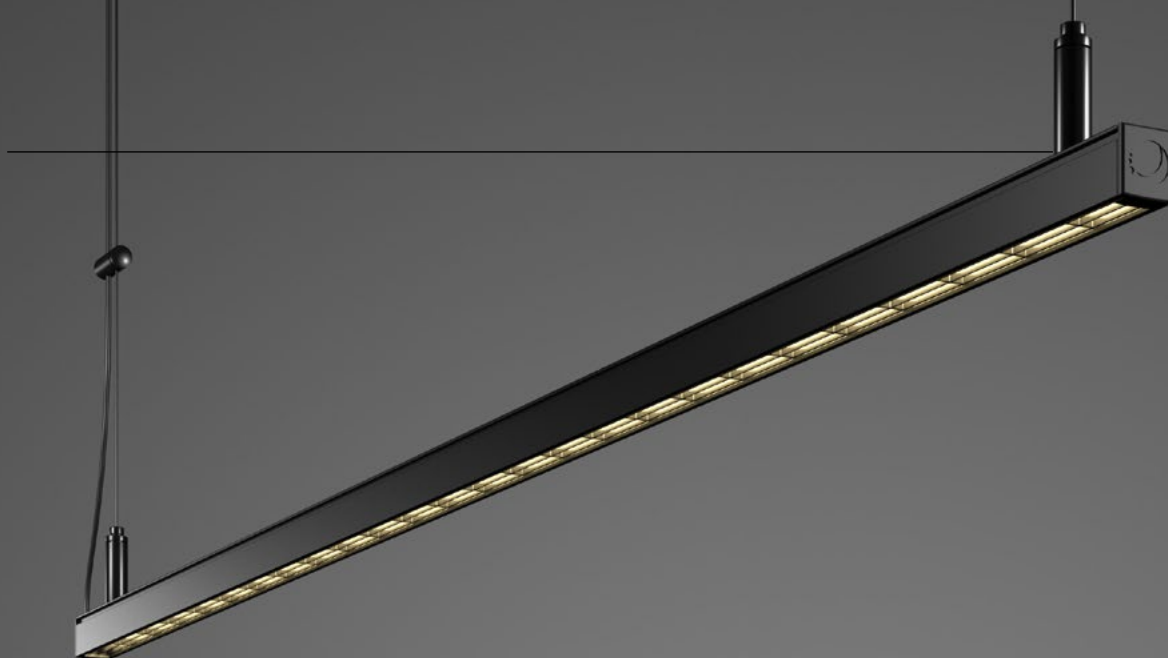

Forma offers the perfect combination of performance and aesthetics. Versatile product lengths along with 90-degree corner options allow the fitting to be tailored to create the perfect lighting effect to complement your unique project.

This range can be supplied as a suspended pendant or a surface mounted fitting in three wattage options (11W, 16W and 33W). Many other customizable options are available, including louvres to reduce glare and custom profile colours.

POWER

11W

11.2W / metre



SD

LL

HL

16W

16.8W / metre



SD

LL

HL

33W

33.6W / metre



SD

LL

HL

COLOUR TEMPERATURE

2700K

3000K

4000K



SEAMLESS CORNER OPTIONS

Specially designed corner locks allow for continuous illumination around 90-degree corners. Seamless corner options are available for both suspended and surface mounted fittings, enabling more flexibility to the sleek and minimal design of Forma.

HIGHLY VERSATILE LENGTH OPTIONS

Highly versatile length options allow the user to achieve accurate and adaptable lengths. Forma can achieve any desired length in 37.5mm increments.



LONG OPERATING LIFE

Coolon products use the world's most reputable LED manufacturers and the latest available standards to adequately report lumen maintenance. We strive to drive LEDs under their nominal current and use state-of-the-art heat dissipation methods, leading to durable electronics.



VARIOUS CCT & COLOUR BINNING CONSISTENCY

All products are offered in various colour temperatures, and manufactured using tighter bins, ensuring excellent consistency and uniformity.



5 YEARS WARRANTY

Coolon luminaires are covered by a solid comprehensive manufacturer's warranty that covers a range of possible defects and performance parameters throughout the duration of the warranty period.



PROUDLY MADE IN AUSTRALIA













Our products are designed and manufactured in Australia. Engineered to perfection, using only the highest quality components and highly skilled labour, each luminaire is assembled and thoroughly tested to ensure that it exceeds the highest standards.

• Pictured with Longitudinal Louvre

■ TECHNICAL SPECIFICATIONS

	11W VERSION	16W VERSION	33W VERSION
Part Number	STR-FORMA		
Description	Forma Low Power LED Strip		
Segment Length (S)	300mm		
Sub-Segment Length (A)	37.5mm		
Number of Sub-Segments	8		
Segment Width	10.50mm		
LED Pitch	5.35mm		
LEDs Per Segment	56		
LEDs Per Sub Segment	7		
Operating Voltage	42VDC		
Typical Power Consumption per Segment	3.3W	5W	10W
Typical Power Consumption per Metre	11.2W/Metre	16.8W/Metre	33.6W/Metre
Colour Rendering Index (CRI)	80 (Standard) up to 90		
Dimmable	Through DRV-DALIPOINT-1X5A, DRV-DALIPOINT-1X10A-IP or DRV-DIMMERPOINT-1X10A (sold separately)		
External Heatsink Required	No		
Ambient Operating Temp	Ta -40°C to 50°C		
Reported Lumen Maintenance TM21-11 (@ Ts = 55°C, If = 65mA)	L70 (12K) > 72,000 hours L90 (12K) = 59,000 hours Forma max. operating values (@ Ts = 40°C, If = 30mA)		
IP Rating	IP40		
Max Continuous Connection Length	Please refer to installation limitations		

▪ LUMEN / METRE MATRIX

POWER	LUMINOUS FLUX		
	2700K	3000K	4000K
11W 11.2W / metre			
SD Profile (White) 	1,000 lm / metre	1,000 lm / metre	1,000 lm / metre
SD Profile (Black) 	630 lm / metre	630 lm / metre	630 lm / metre
LL Profile (White) 	490 lm / metre	490 lm / metre	490 lm / metre
LL Profile (Black) 	360 lm / metre	360 lm / metre	360 lm / metre
HL Profile (White) 	255 lm / metre	255 lm / metre	255 lm / metre
HL Profile (Black) 	200 lm / metre	200 lm / metre	200 lm / metre
16W 16.8W / metre			
SD Profile (White) 	1,520 lm / metre	1,520 lm / metre	1,520 lm / metre
SD Profile (Black) 	960 lm / metre	960 lm / metre	960 lm / metre
LL Profile (White) 	710 lm / metre	710 lm / metre	710 lm / metre
LL Profile (Black) 	525 lm / metre	525 lm / metre	525 lm / metre
HL Profile (White) 	350 lm / metre	350 lm / metre	350 lm / metre
HL Profile (Black) 	260 lm / metre	260 lm / metre	260 lm / metre

- Specific lumen output and IES files available on request
- Performance is effected by LED bin, CRI and profile colour. Luminous flux (per metre) is based on lowermost value at time of measure.
- ✘ : CCT / Profile combination NOT AVAILABLE NM : Lumen output NOT MEASURED

▪ LUMEN / METRE MATRIX

POWER	LUMINOUS FLUX		
	2700K	3000K	4000K
33W 33.6W / metre			
SD Profile (White) 	2,650 lm / metre	2,650 lm / metre	2,650 lm / metre
SD Profile (Black) 	1,650 lm / metre	1,650 lm / metre	1,650 lm / metre
LL Profile (White) 	1,330 lm / metre	1,330 lm / metre	1,330 lm / metre
LL Profile (Black) 	990 lm / metre	990 lm / metre	990 lm / metre
HL Profile (White) 	680 lm / metre	680 lm / metre	680 lm / metre
HL Profile (Black) 	510 lm / metre	510 lm / metre	510 lm / metre

- Specific lumen output and IES files available on request
- Performance is effected by LED bin, CRI and profile colour. Luminous flux (per metre) is based on lowermost value at time of measure.
- ✘ : CCT / Profile combination NOT AVAILABLE NM : Lumen output NOT MEASURED

■ DIMENSIONS

For final strip lengths please refer to the "Product Length" table.

FORMA STANDARD

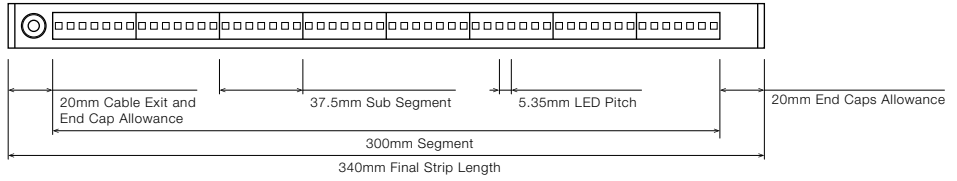

FORMA CORNER

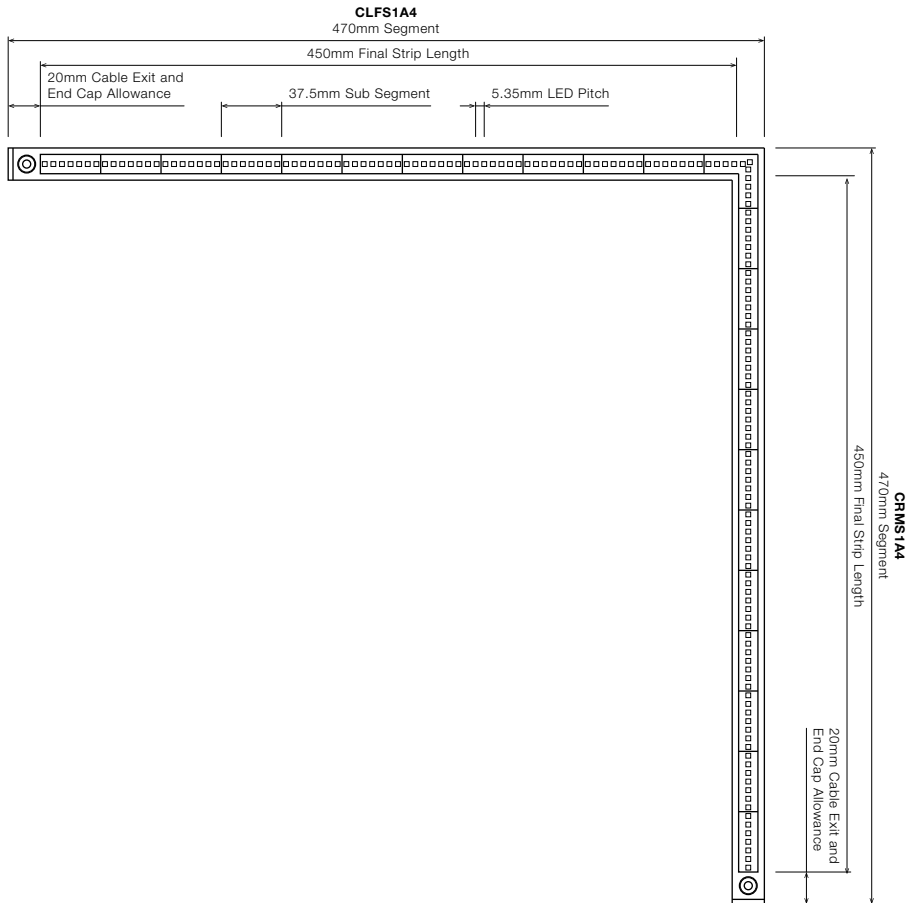

■ DIMENSIONS
(CONTINUED)

STANDARD PROFILE

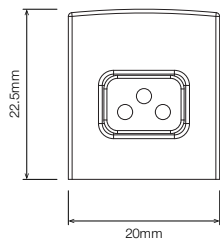

WITH STAINLESS STEEL C-CLIP

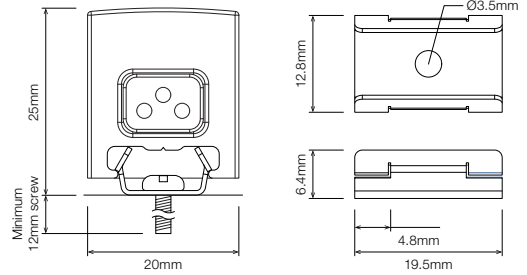

WITH ROTATING CLIP

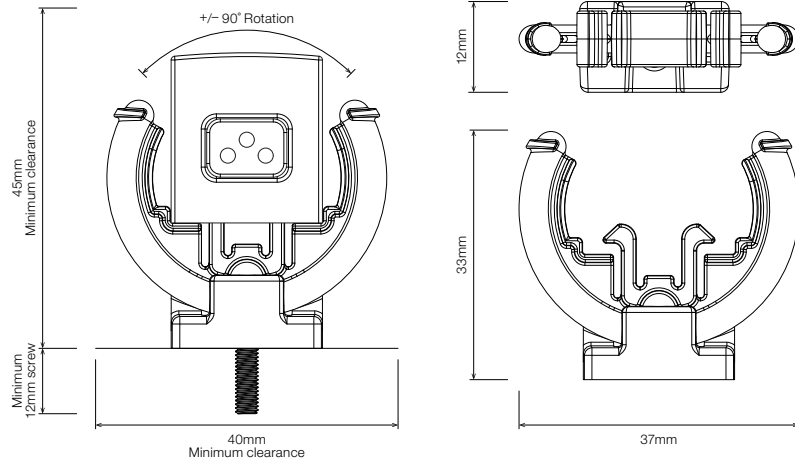

WITH SUSPENSION KIT

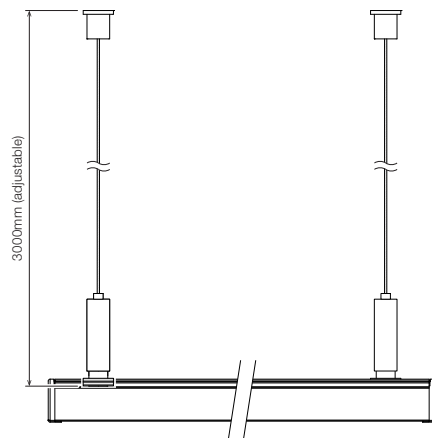

WITH LOCKING CLIP

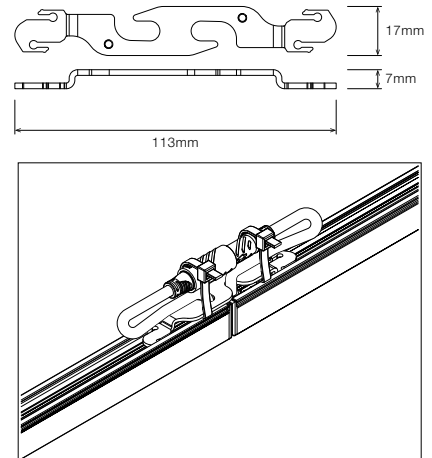

▪ PRODUCT LENGTH

FORMA STANDARD

FULL SEGMENTS	SUB SEGMENTS	FINAL LENGTH
0	1	77.5mm
0	2	115mm
0	3	152.5mm
0	4	190mm
0	5	227.5mm
0	6	265mm
0	7	302.5mm
1	0	340mm
1	1	377.5mm
1	2	415mm
1	3	452.5mm
1	4	490mm
1	5	527.5mm
1	6	565mm
1	7	602.5mm
2	0	640mm
2	1	677.5mm
2	2	715mm
2	3	752.5mm
2	4	790mm
2	5	827.5mm
2	6	865mm
2	7	902.5mm
3	0	940mm
3	1	977.5mm
3	2	1,015mm
3	3	1,052.5mm
3	4	1,090mm
3	5	1,127.5mm
3	6	1,165mm
3	7	1,202.5mm
4	0	1,240mm
4	1	1,277.5mm
4	2	1,315mm
4	3	1,352.5mm
4	4	1,390mm
4	5	1,427.5mm
4	6	1,465mm
4	7	1,502.5mm
5	0	1,540mm
5	1	1,577.5mm
5	2	1,615mm
5	3	1,652.5mm
5	4	1,690mm
5	5	1,727.5mm
5	6	1,765mm
5	7	1,802.5mm
6	0	1,840mm

FULL SEGMENTS	SUB SEGMENTS	FINAL LENGTH
6	1	1,877.5mm
6	2	1,915mm
6	3	1,952.5mm
6	4	1,990mm
6	5	2,027.5mm
6	6	2,065mm
6	7	2,102.5mm
7	0	2,140mm
7	1	2,177.5mm
7	2	2,215mm
7	3	2,252.5mm
7	4	2,290mm
7	5	2,327.5mm
7	6	2,365mm
7	7	2,402.5mm
8	0	2,440mm
8	1	2,477.5mm
8	2	2,515mm
8	3	2,552.5mm
8	4	2,590mm
8	5	2,627.5mm
8	6	2,665mm
8	7	2,702.5mm
9	0	2,740mm
9	1	2,777.5mm
9	2	2,815mm
9	3	2,852.5mm
9	4	2,890mm
9	5	2,927.5mm
9	6	2,965mm
9	7	3,002.5mm
10	0	3,040mm
10	1	3,077.5mm
10	2	3,115mm
10	3	3,152.5mm
10	4	3,190mm
10	5	3,227.5mm
10	6	3,265mm
10	7	3,302.5mm

■ Confirm interstate courier compliance

▪ Custom length subject to availability

⚠ WARNING

Do not bend LED strip when removing from mounting clips.

Gently twist LED Strip to remove from mounting clips.

⚠ WARNING

PLEASE HANDLE LONG LED STRIPS WITH CARE.

LED Strips must not be bent.

When handling LED Strips, please ensure that they are kept straight.

▪ **PRODUCT LENGTH**
(CONTINUED)

FORMA CORNER

- CLF** - Corner Left Female Connector
- CLM** - Corner Left Male Connector
- CRF** - Corner Right Female Connector
- CRM** - Corner Right Male Connector

FULL SEGMENTS	SUB SEGMENTS	FINAL LENGTH
1	4	470mm
1	5	507.5mm
1	6	545mm
1	7	582.5mm
2	0	620mm
2	1	657.5mm
2	2	695mm
2	3	732.5mm
2	4	770mm
2	5	807.5mm
2	6	845mm
2	7	882.5mm
3	0	920mm

▪ Corner configuration only available for 11W and 16W.

⚠ WARNING

Do not bend LED strip when removing from mounting clips.

Gently twist LED Strip to remove from mounting clips.

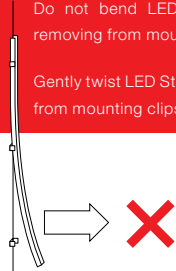

⚠ WARNING

PLEASE HANDLE LONG LED STRIPS WITH CARE.

LED Strips must not be bent.

When handling LED Strips, please ensure that they are kept straight.

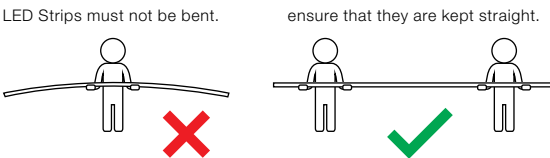

■ DIFFUSER
/ LOUVRE

SD - No Louvre



LL - Longitudinal Louvre

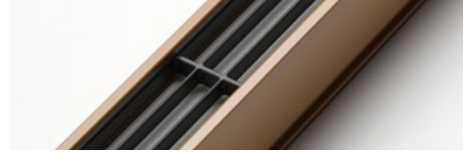

HL - Honeycomb Louvre



■ PROFILE
COLOUR

BLK - Black (Standard)



WHT - White



CST - Custom Colour ¹

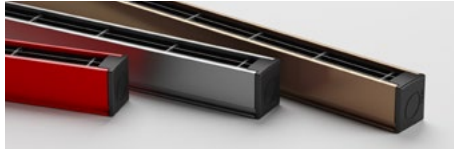

¹ Custom colours available on request.

WIRING CONFIGURATION

CONNECTOR TYPE	DRAWING	MALE	FEMALE
WR2OS Wire 2 Core One Side			
WR2BS Wire 2 Core Both Sides			
OC2MO Connector 2pin Male Only			
OC2MF Connector 2pin Male + Female			
LC2MO ¹ Locking Connector 2pin Male Only			
LC2MF ¹ Locking Connector 2pin Male + Female			
RC2OS Round Cable 2 Core One Side			
RC2BS Round Cable 2 Core Both Sides			
SMPLC Sample Type Connector 2.5mm			

- For detailed information on Outdoor IP67 connector please contact Coolon.
- Please consult Coolon for details on extension cable between LED fittings, drivers and power supplies.
- ¹ Locking Connectors (LC2MO / LC2MF) only available with Wire from Back (WB) and Suspension Kit.

WIRING COLOUR CODE	
Red	+ VDC
Black	GND

WIRING POSITION

WB - Wire from back

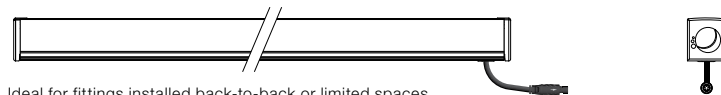

Ideal for fittings installed back-to-back or limited spaces.
Wiring from Back (WB) only available for LC2MO, LC2MF, RC2OS & RC2BS.

WS - Wire from Side

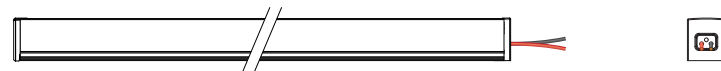

Ideal for fittings installed individually or vertically.
Wiring from Side (WS) only available for WR2OS, WR2BS, OC2MO, OC2MF & SMPLC.

IP RATING

IP40

Protected against solid objects greater than 1mm. No protection against liquids.

■ INSTALLATION LIMITS

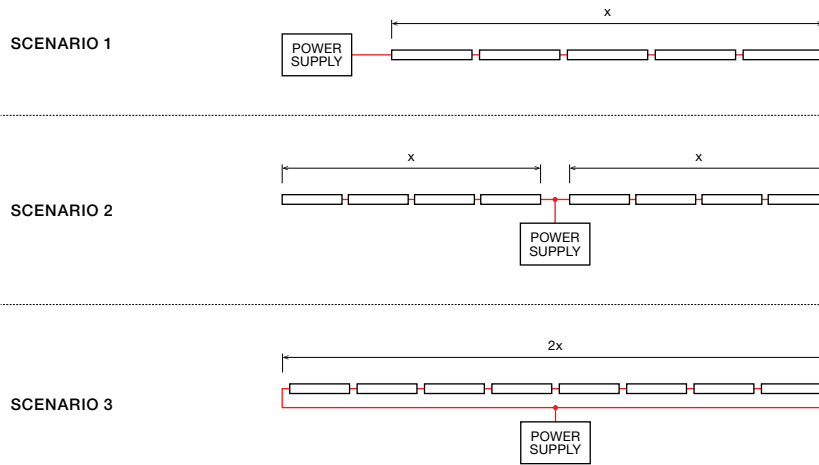

11W VERSION

MAX. CONTINUOUS CONNECTION LENGTH (X)	CONNECTOR TYPE
15,000 mm	With standard 2 pin locking connectors (LC2MO / LC2MF)
20,000 mm	With 2 core (WR2BS / RC2OS / RC2BS)
9,000 mm	With 2 pin connectors (OC2MO / OC2MF)

▪ Please consult Coolon for details on extension cable between LED fittings, drivers and power supplies.

16W VERSION

MAX. CONTINUOUS CONNECTION LENGTH (X)	CONNECTOR TYPE
10,000 mm	With standard 2 pin locking connectors (LC2MO / LC2MF)
14,000 mm	With 2 core (WR2BS / RC2OS / RC2BS)
6,000 mm	With 2 pin connectors (OC2MO / OC2MF)

▪ Please consult Coolon for details on extension cable between LED fittings, drivers and power supplies.

33W VERSION

MAX. CONTINUOUS CONNECTION LENGTH (X)	CONNECTOR TYPE
5,000 mm	With standard 2 pin locking connectors (LC2MO / LC2MF)
7,000 mm	With 2 core (WR2BS / RC2OS / RC2BS)
3,000 mm	With 2 pin connectors (OC2MO / OC2MF)

▪ Please consult Coolon for details on extension cable between LED fittings, drivers and power supplies.

⚠ WARNING

Avoid connecting multiple power supplies into a single circuit, unless they are specifically designed to do so.

✗

✗

ORDERING EXAMPLE

STR - FORMA - 16W - 3.0K - S2A0 - SD - WHT - LC2MF - WB - 100 - IP40

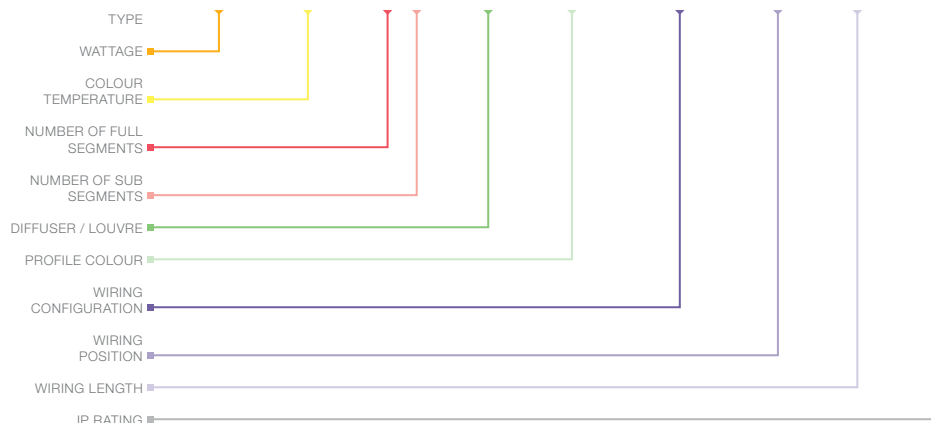

■ **WATTAGE** PAGE 04

11W	11.2W per Metre
16W	16.8W per Metre
33W	33.6W per Metre

■ **COLOUR TEMPERATURE** PAGE 04

2.7K	2700K CRI 80
2.7KCRI	2700K CRI 90
3.0K	3000K CRI 80
3.0KCRI	3000K CRI 90
4.0K	4000K CRI 80
4.0KCRI	4000K CRI 90

■ **PRODUCT LENGTH** PAGE 06

FULL SEGMENTS	SUB SEGMENTS
S1	A0
S2	A1
S3	A2
S4	A3
S5	A4
S6	A5
S7	A6
S8	A7
S9	
CORNER LENGTHS ²	
CLF	Corner Left Female Connector
CLM	Corner Left Male Connector
CRF	Corner Right Female Connector
CRM	Corner Right Male Connector

■ **DIFFUSER / LOUVRE** PAGE 08

SD	No Louvre
LL	Longitudinal Louvre
HL	Honeycomb Louvre

■ **PROFILE COLOUR** PAGE 08

BLK	Black (Standard)
WHT	White
CST	Custom Colour

■ **WIRING CONFIGURATION** PAGE 09

WR2OS	Wire 2 Core One Side
WR2BS	Wire 2 Core Both Sides
OC2MO	Connector 2 pin Male Only
OC2MF	Connector 2 pin Male + Female
LC2MO ⁴	Locking Connector 2 pin Male Only
LC2MF ⁴	Locking Connector 2 pin Male + Female
RC2OS ⁵	Round Cable 2 Core One Side
RC2BS ⁵	Round Cable 2 Core Both Sides
SMPLC	Sample Type Connector 2.5mm

■ **WIRING POSITION** PAGE 09

WB	Wire from Back
WS	Wire from Side

■ **WIRING LENGTH**

100	100mm
250	250mm
500	500mm
1000	1000mm

■ **IP RATING** PAGE 09

IP40	Indoor Use
------	------------

¹ Other CCT subject to availability.



² Corner configuration only available for 11W and 16W.

³ Custom colours available on request.

⁴ Locking Connectors (LC2MO / LC2MF) only available with Wire from Back (WB) and Suspension Kit.

⁵ Round Cable (RC2OS / RC2BS) only available with Wire from Back (WB).

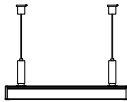
■ ACCESSORIES

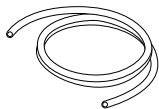
	PRODUCT CODE	DESCRIPTION
MOUNTING CLIP ¹		
	MC-CCLIP20	Stainless Steel C-Clip for P20 Profile
	MC-STR-P20R-BLK	Rotating Clip Mount for P20 Profile - Black
	MC-STR-P20R-WHT	Rotating Clip Mount for P20 Profile - White
¹ Recommended spacing between Mounting Clips is maximum 300mm.		
SUSPENSION KIT ²		
	MSK-STR-3000-0CG-BLK	Suspension Kit, 3000mm Wire, No Cable Grip, Black
	MSK-STR-3000-1CG-BLK	Suspension Kit, 3000mm Wire, 1 Cable Grip, Black
	MSK-STR-3000-2CG-BLK	Suspension Kit, 3000mm Wire, 2 Cable Grips, Black
² Recommended spacing between Suspensions is maximum 1000mm. Minimum of two Suspensions required per fitting.		
DRIVER		
	DRV-DALIPOINT-1X5A	DALI 5 Amps 1 Channel LED Driver
	DRV-DALIPOINT-IP1X10A	DALI 10 Amps 1 Channel Outdoor LED Driver
	DRV-DIMMERPOINT-1X10A	Rotary Wall-Mount LED Driver
	DRV-RDM-P4	DMX / RDM 4 Channel LED Driver
POWER SUPPLIES		
	PWR-HLG-60H-42AU	Mean Well Power Supply HLG 60W 42V IP67
	PWR-HLG-150H-42AU	Mean Well Power Supply HLG 150W 42V IP67
	PWR-HLG-240H-42AU	Mean Well Power Supply HLG 240W 42V IP67
CABLE EXTENSIONS		
	CBLEXT-STR-WR2-IP40-3M	3m Cable Extension for Strips 1x Red, 1x Black, 0.75mm ² wire
	CBLEXT-STR-WR2-IP40-5M	5m Cable Extension for Strips 1x Red, 1x Black, 0.75mm ² wire
	CBLEXT-STR-OC2-IP65-0.6M	0.6m Connector Extension for Strips 1x Red, 1x Black, 0.75mm ² wires
	CBLEXT-STR-OC2-IP65-3M	3m Connector Extension for Strips 1x Red, 1x Black, 0.75mm ² wires
	CBLEXT-STR-OC2-IP65-5M	5m Connector Extension for Strips 1x Red, 1x Black, 0.75mm ² wires
	CBLEXT-STR-WR4-IP40-3M	3m Cable Extension for Strips 2x Red, 2x Black, 0.75mm ² wires
	CBLEXT-STR-WR4-IP40-5M	5m Cable Extension for Strips 2x Red, 2x Black, 0.75mm ² wires
	CBLEXT-STR-OC4-IP65-3M	3m Connector Extension for Strips 2x Red, 2x Black, 0.75mm ² wires
	CBLEXT-STR-OC4-IP65-5M	5m Connector Extension for Strips 2x Red, 2x Black, 0.75mm ² wires