

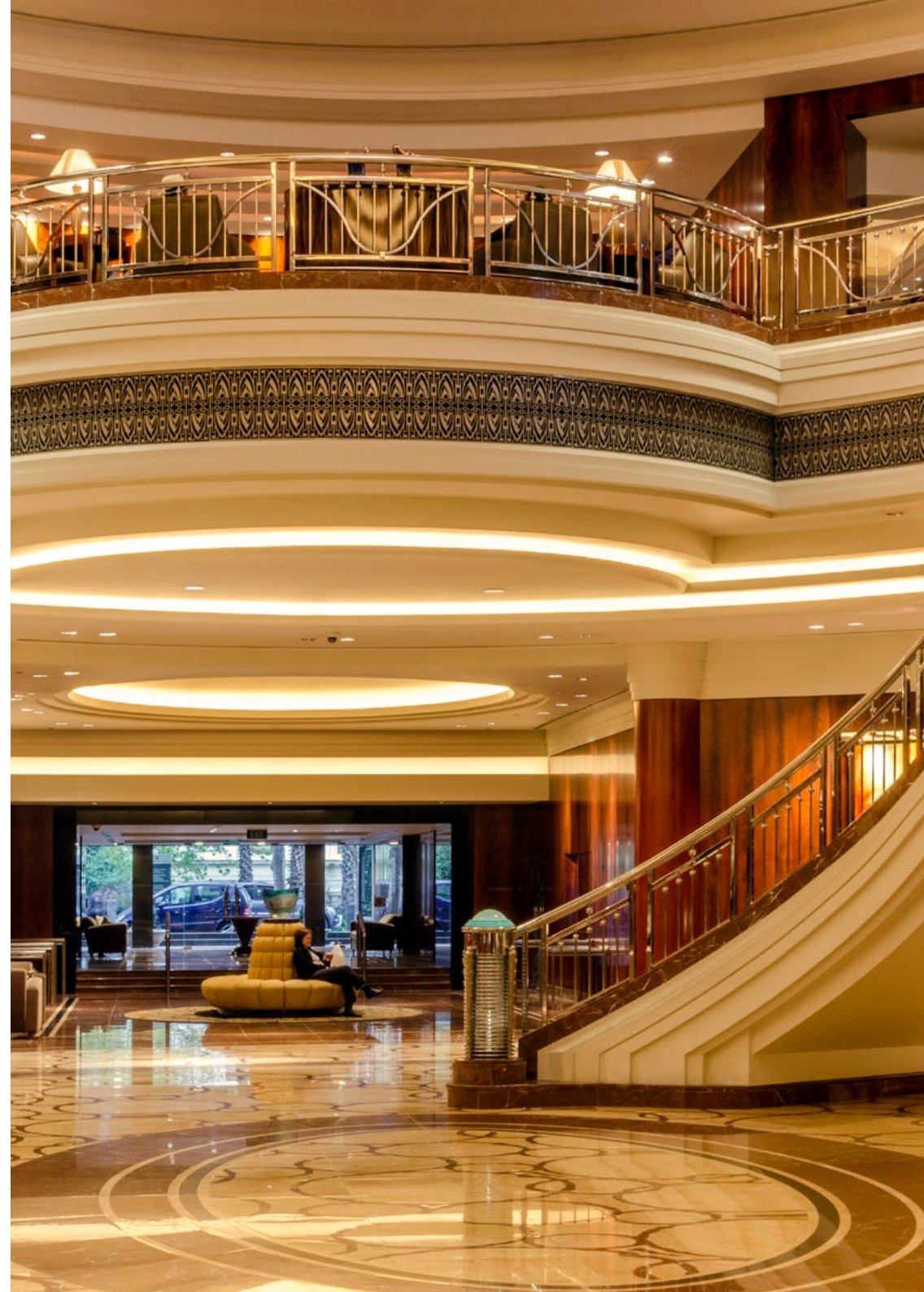

# CL STRIP PROFILE INSTALLATION INSTRUCTIONS



## ▪ DIMENSIONS WITH MOUNTING CLIP

CL Profile

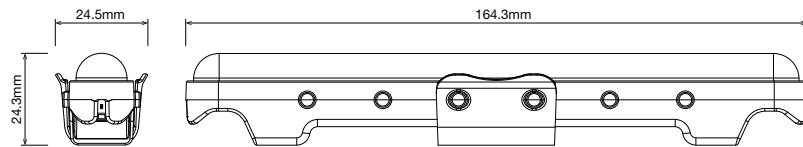

## ⚠ ATTENTION

- Please observe / follow the instructions methodically.
- Please ensure the units are handled with extreme care.
- Do not remove LED strips from packaging prematurely. Only remove from packaging when ready for installation.
- Failure to observe installation instructions and handling will void warranty of the product.

## ▪ WIRING OPTIONS

2 wires (RB) – Indoor only.

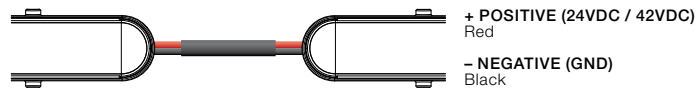

3 wires (RBW) – Indoor only.

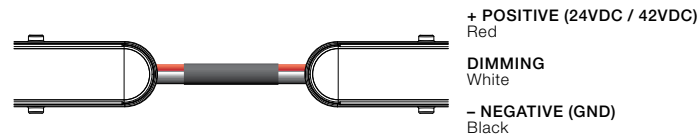

## STEP 1

Before you begin installation, ensure that you understand the fitting layout required as supplied fitting lengths may vary.

Refer to the supplied cut sheet for length breakdowns.

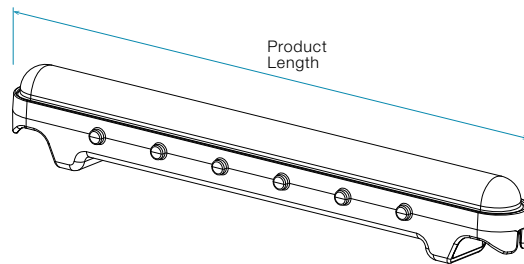

## WIRING

Wire the fitting to the correct power supply as advised on the cut sheet.

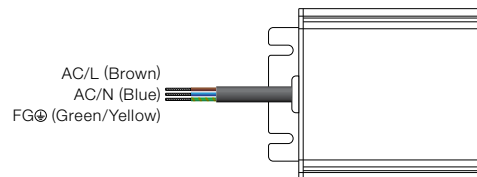
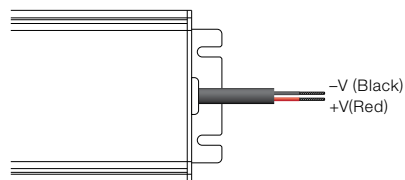

## MOUNTING CLIPS

### STEP 2

Prepare mounting clips and screws (Ø3mm with a minimum length of 12mm).

Measure out the spacing between each mounting clip, spacing for CL is 180mm.

Secure clips with screws on timber or metal surface ensuring that mounting clips are straight.

*\*Mounting clips may be mounted using tape instead of screws*

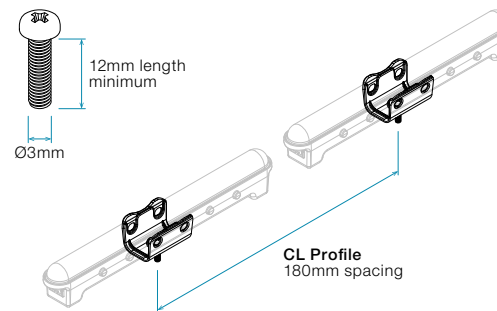

### STEP 3

Tilt LED segment on one edge and secure the other edge by latching to mounting clips.

Slide profile until the circular tabs align with the holes in the clip to lock into place.

