



ARIS UG

LINEAR MEDIUM POWER LNR-ARIS UG





The Aris UG is a compact and understated linear architectural luminaire. At 25x25mm in size and available in various lineal lengths, the Aris UG is offered with a Uniform Glowing diffuser where no LEDs are visible along the length of the diffuser.

The Aris UG is ideal for direct/visible lighting applications where the source of the luminaire is important to the architectural aesthetic.

POWER

LUMINOUS FLUX

11W

11W / metre

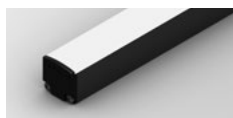

UG · 726 lm / metre

28W

28W / metre

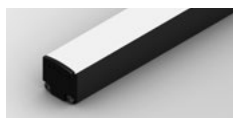

UG · 1,800 lm / metre

40W

40W / metre

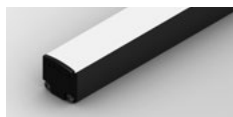

UG · 2,500 lm / metre

COLOUR TEMPERATURE

2700K

3000K

4000K

COMPACT SIZE

Reduced profile dimensions allows for ease of installation in confined spaces that could not be achieved with previous halogen counterparts. Installed in visible sight the Aris UG also pays respect to the interior design with minimal disruption to the aesthetics.



CUSTOMIZATION AT ITS BEST

The Aris UG is a highly versatile and customizable luminaire. Pick from a number of linear lengths, colour temperatures, profile colours and mounting options. The Aris UG can be used as a marker luminaire or a flood light.



LONG OPERATING LIFE

Coolon products use the world's most reputable LED manufacturers and the latest available standards to adequately report lumen maintenance. We strive to drive LEDs under their nominal current and use state-of-the-art heat dissipation methods, leading to durable electronics.



VARIOUS CCT & COLOUR BINNING CONSISTENCY

All products are offered in various colour temperatures, and manufactured using tighter bins, ensuring excellent consistency and uniformity.



5 YEARS WARRANTY

Coolon luminaires are covered by a solid comprehensive manufacturer's warranty that covers a range of possible defects and performance parameters throughout the duration of the warranty period.



PROUDLY MADE IN AUSTRALIA

Our products are designed and manufactured in Australia. Engineered to perfection, using only the highest quality components and highly skilled labour, each luminaire is assembled and thoroughly tested to ensure that it exceeds the highest standards.

TECHNICAL SPECIFICATIONS

	11W VERSION	28W VERSION	40W VERSION
Product Code	LNR-ARIS UG		
Description	Aris UG Linear Medium Power Projector		
Body	Aluminium Alloy Body		
Finish	Powder Coated Black (Standard), Various Colours Available		
Cover	Polycarbonate		
End Caps	Polycarbonate		
Segment Length (S)	300mm		
Sub-Segment Length (A)	37.5mm		
Number of Sub-Segments	8		
LED Pitch	5.3mm (W) x 5.3mm (H)		
LEDs Per Segment	112		
LEDs Per Sub Segment	14		
Operating Voltage	42VDC		
Typical Power Consumption per Segment	2.18W per 300mm Segment	8.50W per 300mm Segment	12.00W per 300mm Segment
Typical Power Consumption per Metre	11W per Metre	28W per Metre	40W per Metre
Typical Current	72mA per 300mm Segment	200mA per 300mm Segment	280mA per 300mm Segment
Colour Rendering Index (CRI)	80+		
Dimmable	Through DRV-DALIPOINT-1X5A, DRV-DALIPOINT-1X10A-IP or DRV-DIMMERPOINT-1X10A (sold separately)		
Luminous Flux per Metre (lm/M)	725 lm/Metre	1,800 lm/Metre	2,500 lm/Metre
Ambient Operating Temp	Ta -20°C to 50°C		
Thermal Management	No		
Reported Lumen Maintenance TM21-11 (@ Ts = 55°C, If = 65mA)	L70 (12K) > 72,000 hours L90 (12K) = 59,000 hours Aris UG max. operating values (@ Ts = 40°C, If = 35mA)		
IP Rating	IP40 (Standard)		
Max Continuous Connection Length	Please refer to installation limitations		

COLOUR BINNING

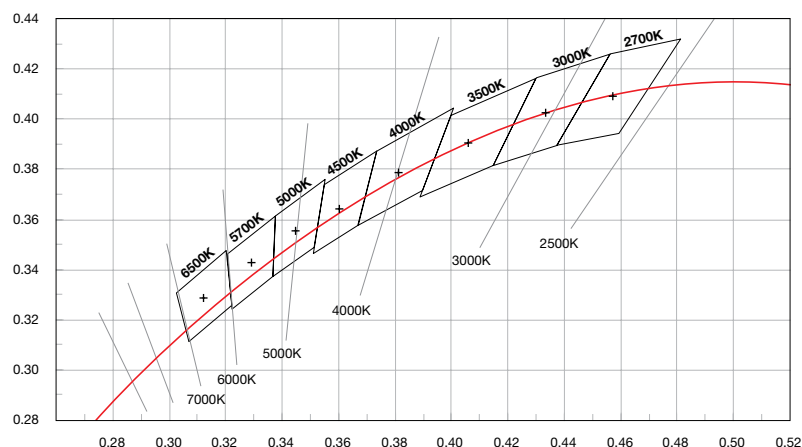

■ DIMENSIONS

For final strip lengths please refer to the "Product Length" table.

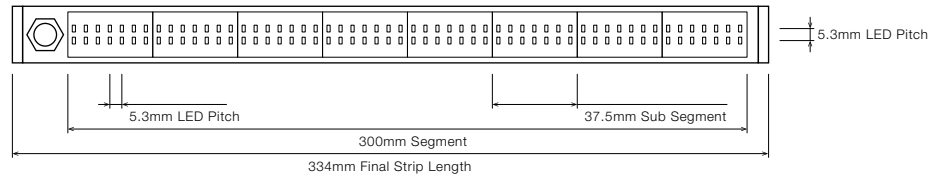

STANDARD PROFILE

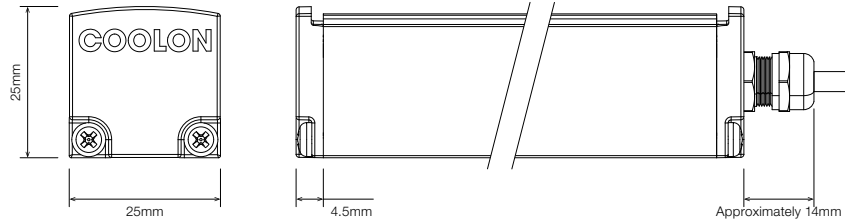

STAINLESS STEEL C-CLIP ¹

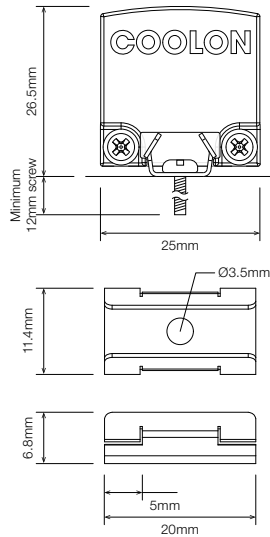

CABLE EXTENSION JOINER

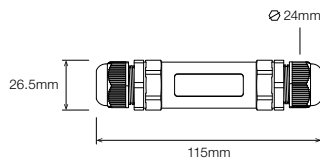

ROTATING MOUNTING BRACKET ¹

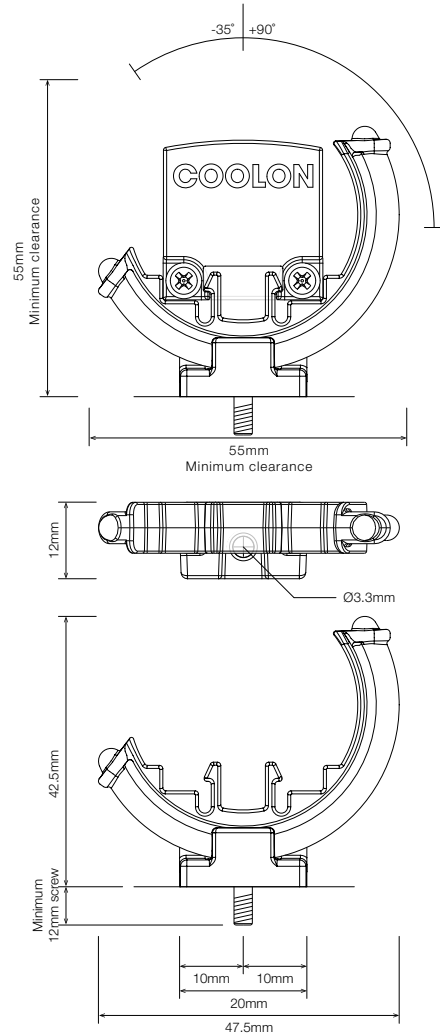

¹ Recommended spacing between Mounting Brackets is maximum 500mm and Mounting Clips is maximum 300mm.

■ PRODUCT LENGTH

FULL SEGMENTS	SUB SEGMENTS	EXACT STRIP LENGTH	FINAL LENGTH
S0	A1	37.5mm	71.5mm
S0	A2	75mm	109mm
S0	A3	112.5mm	146.5mm
S0	A4	150mm	184mm
S0	A5	187.5mm	221.5mm
S0	A6	225mm	259mm
S0	A7	262.5mm	296.5mm
S1	A0	300mm	334m
S2	A0	600mm	634mm ¹
S3	A0	900mm	934mm ¹
S4	A0	1,200mm	1,234mm ¹
S5	A0	1,500mm	1,534mm ¹
S6	A0	1,800mm	1,834mm ¹
S7	A0	2,100mm	2,134mm ¹
S8	A0	2,400mm	2,434mm ¹
S9	A0	2,700mm	2,734mm ¹
S10	A0	3,000mm	3,034mm ¹
S11	A0	3,300mm	3,334mm ¹

¹ Available in additional Sub-Segment Lengths (37.5mm increment)

▪ DIFFUSER

SD - Standard Diffuser



▪ PROFILE COLOUR

BLK - Black

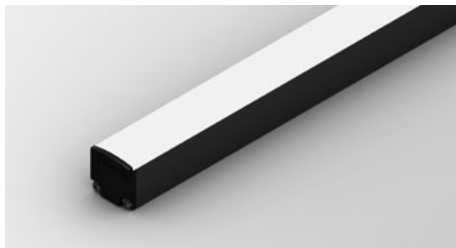

WHT - White

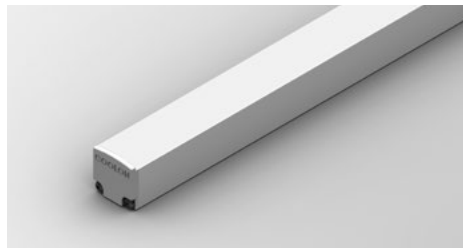

CST - Custom Colour ¹

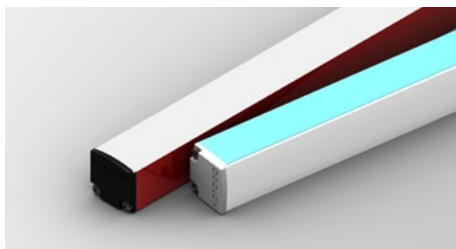

¹ Custom colours available on request

WIRING CONFIGURATION

CONNECTOR TYPE	DRAWING	MALE	FEMALE
WR2OS Wire 2 Core One Side			
OC2.2MO Outdoor Connector 2.2pin Male Only			
SMPLC Sample Type Connector 2.5mm			

- Typical wiring length 1,000mm.
- Please consult Coolon for details on extension cable between LED fittings, drivers and power supplies.

WIRING COLOUR CODE	
Red	+ VDC
Black	GND
White	Dimming

WIRING POSITION

WB - Wire from back



Ideal for fittings installed back-to-back or limited spaces.

WS - Wire from Side



Ideal for fittings installed individually or vertically.

IP RATING

IP40

Protected against solid objects greater than 1mm. No protection against liquids.

■ INSTALLATION LIMITS

SCENARIO 1

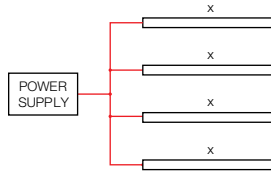

MAX. CONTINUOUS CONNECTION LENGTH (X) CONNECTOR TYPE

3,329 mm	With standard 2 bare wires (WR2OS)
----------	------------------------------------

- Please consult Coolon for details on extension cable between LED fittings, drivers and power supplies.

⚠ WARNING

Avoid connecting multiple power supplies into a single circuit, unless they are specifically designed to do so.

✘

✘

ORDERING EXAMPLE

LNR - ARIS UG - 40W - 2.7K - S2A0 - SD - BLK - WR2OS - WB - IP40

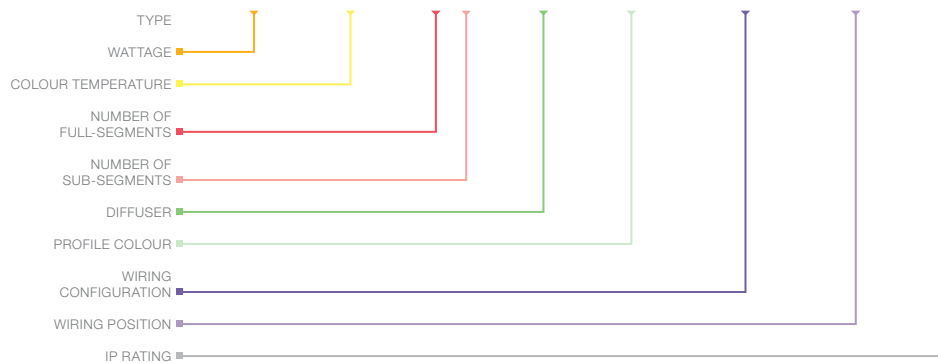

■ **WATTAGE** PAGE 04

11W	11W per metre
28W	28W per metre
40W	40W per metre

■ **COLOUR TEMPERATURE** PAGE 04

2.7K	2700K
3.0K	3000K
4.0K	4000K

■ **PRODUCT LENGTH** PAGE 06

FULL SEGMENTS	SUB SEGMENTS
S1	A0
S2	A1
S3	A2
S4	A3
S5	A4
S6	A5
S7	A6
S8	A7
S9	
S10	
S11	
S12	

■ **DIFFUSER** PAGE 07

SD	Standard Diffuser
----	-------------------

■ **PROFILE COLOUR** PAGE 07

BLK	Black (Standard)
WHT	White
CST	Custom Colour ¹

■ **WIRING CONFIGURATION** PAGE 08

WR2OS	Wire 2 Core One Side
OC2.2MO	Outdoor Connector 2.2pin Male Only
SMPLC	Sample Type Connector 2.5mm

■ **WIRING POSITION** PAGE 08





WB	Wire from Back
WS	Wire from Side

■ **IP RATING** PAGE 08

IP40	Indoor Use
------	------------

¹ Custom colours available on request

■ ACCESSORIES

	PRODUCT CODE	DESCRIPTION
MOUNTING *		
	MC-CCLIP	Stainless Steel C-Clip
	MBR-P25R-BLK	Rotating Mounting Bracket for Aris UG - Black
	MBR-P25R-WHT	Rotating Mounting Bracket for Aris UG - White
* Recommended spacing between Mounting Brackets is maximum 500mm and Mounting Clips is maximum 300mm.		
DRIVER		
	DRV-DALIPOINT-1X5A	Indoor DALI Point 1 Channel Driver 5A
	DRV-DALIPOINT-IP1X10A	Outdoor DALI Point 1 Channel Driver 10A
	DRV-DIMMERPOINT-1X10A	Coolon Wall Dimmer with 10A PWM Output
POWER SUPPLY FOR OUTDOOR USE (IP67)		
	PWR-HLG-60H-42	Mean Well Power Supply HLG 60W 42V
	PWR-HLG-150H-42	Mean Well Power Supply HLG 150W 42V
	PWR-HLG-240H-42	Mean Well Power Supply HLG 240W 42V
CABLE EXTENSIONS		
	CBLEXT-LNR-WR2.1-IP65-3M	3m Length, 3 Core RBW 16AWG Cable Extension with outdoor joiner
	CBLEXT-LNR-WR2.1-IP65-5M	5m Length, 3 Core RBW 16AWG Cable Extension with outdoor joiner
	CBLEXT-LNR-WR2.1-IP65-10M	10m Length, 3 Core RBW 16AWG Cable Extension with outdoor joiner
	CBLEXT-LNR-WR2.1-IP65-20M	20m Length, 3 Core RBW 16AWG Cable Extension with outdoor joiner