

# ATLAS COPCO

## DM45

---

Lighting Design Simulation Report

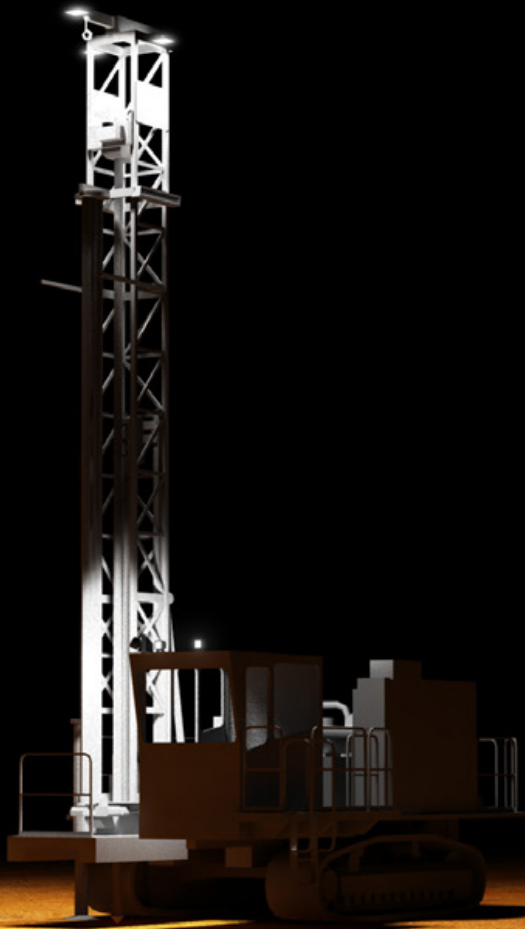

Suggested Layout #1

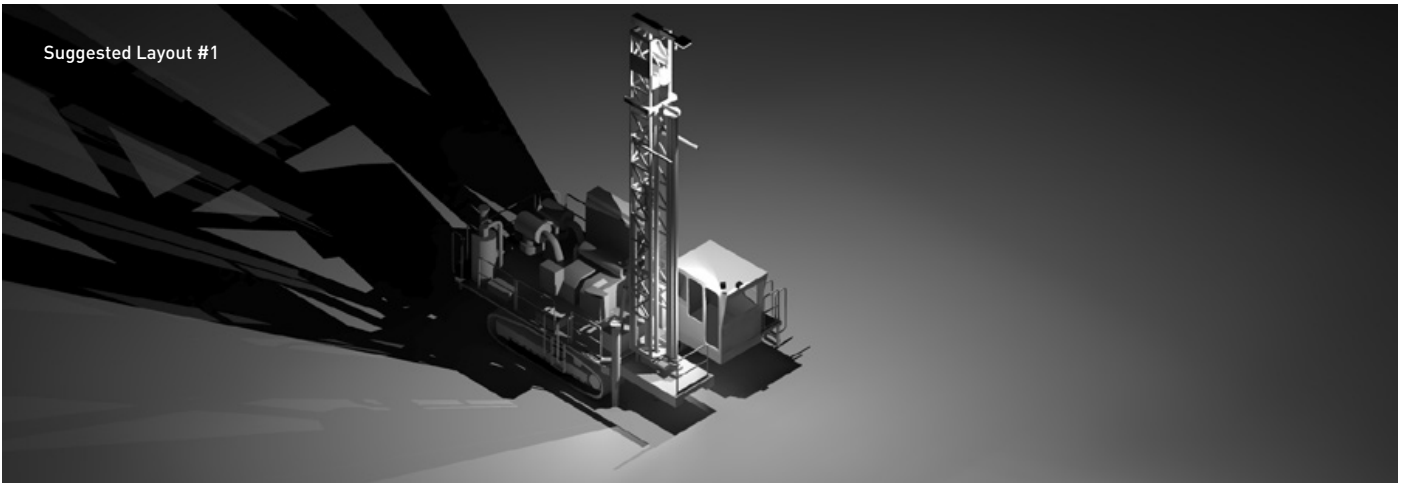

Suggested Layout #2

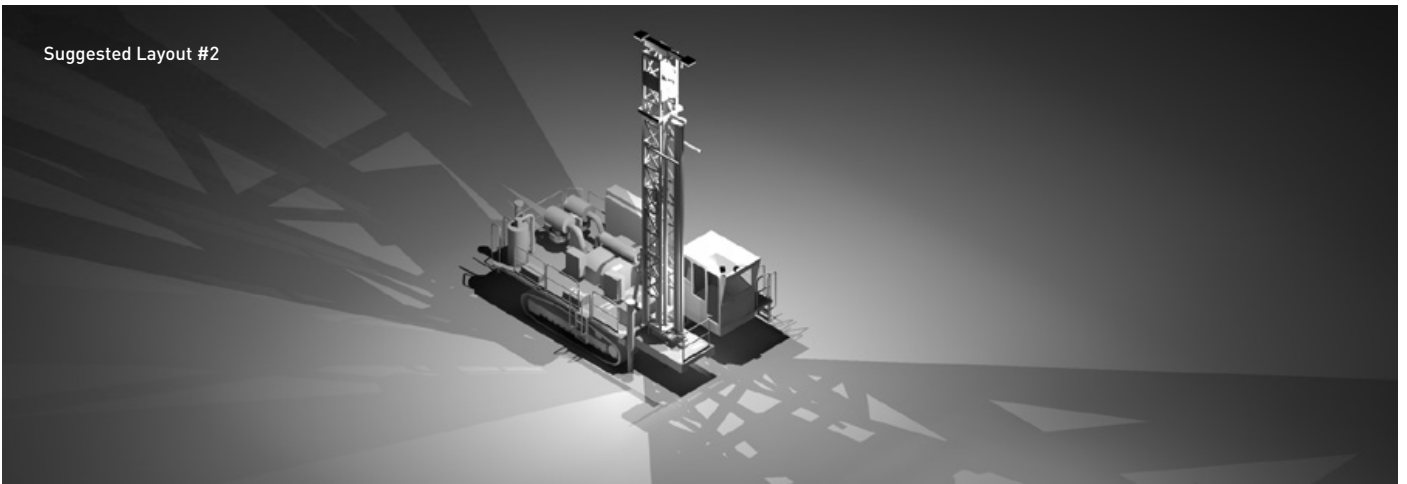

Suggested Layout #3



### SUGGESTED LAYOUT #1

Model No.	Luminaire	Optic Type	Quantity
CP56-NOP-MPB-NPS	CP56 Flood Light	No Optics (120° Beam Angle)	1
CP9-M-XML-NOP-MPB-NPS	CP9 Flood Light	No Optics (120° Beam Angle)	1
CP9-M-XML-O209-MPB-NPS	CP9 Flood Light	O209 - 40° x 18° Beam Angle	1

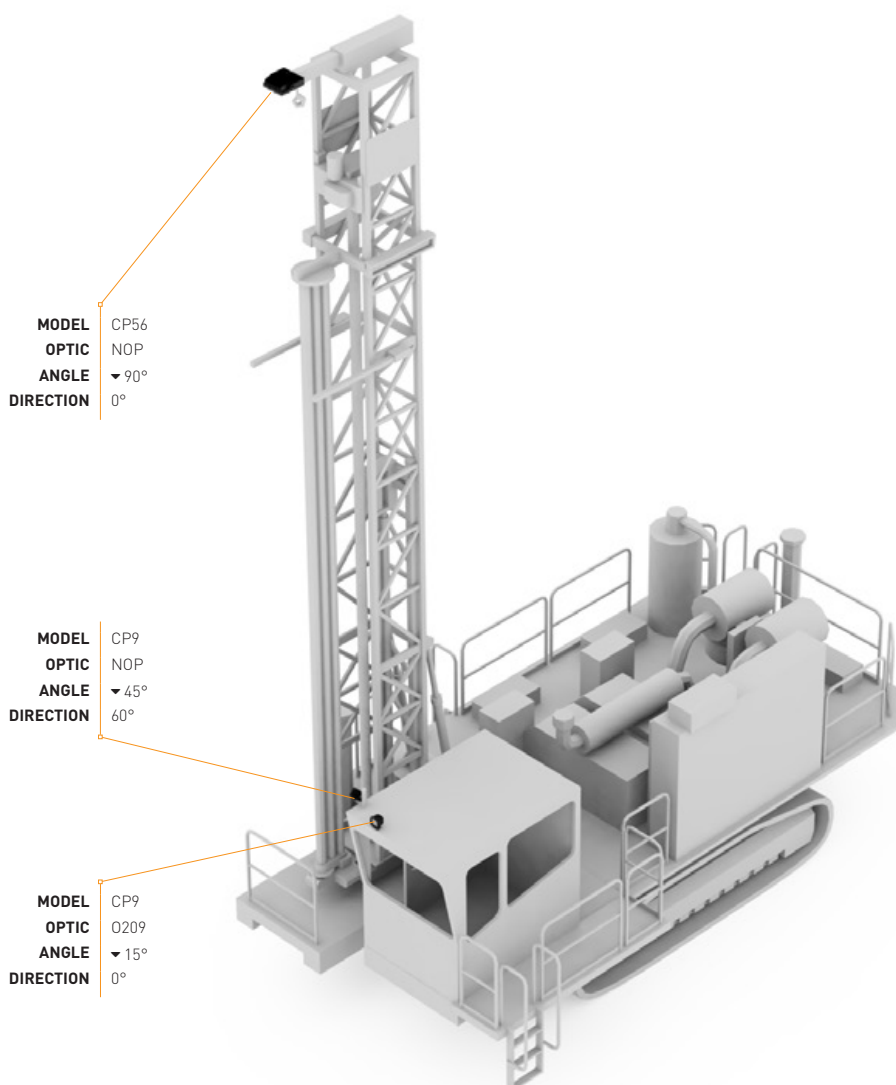

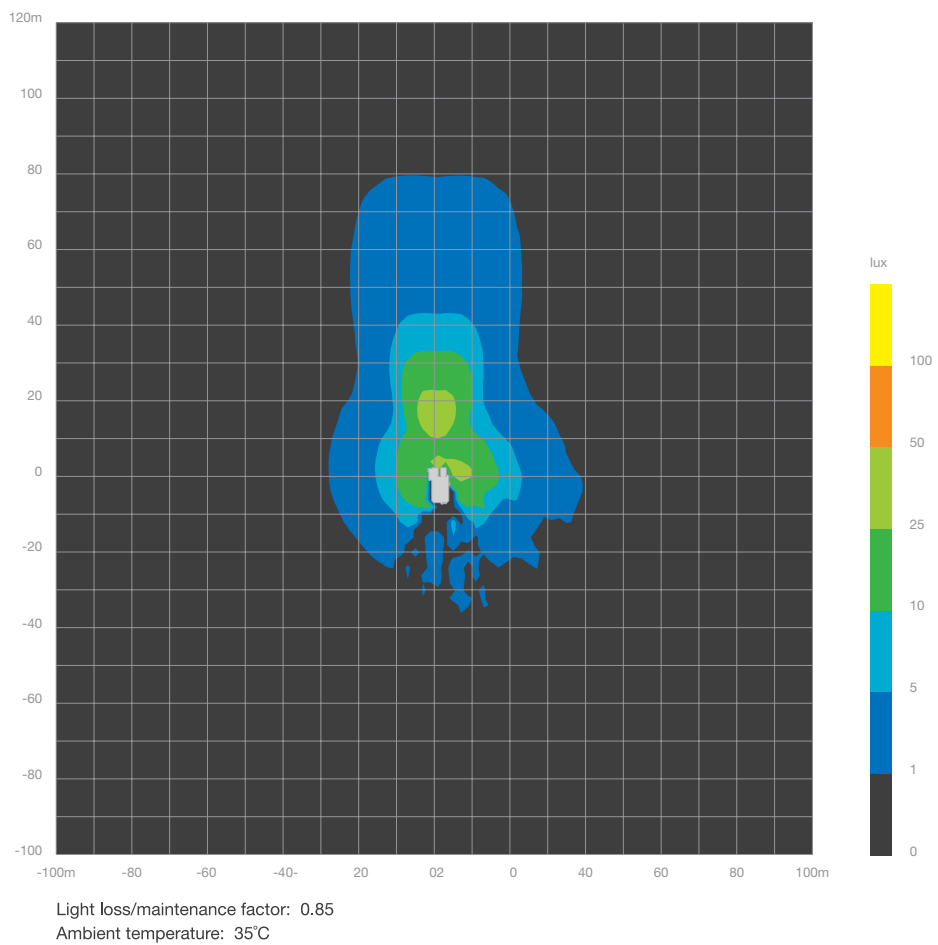
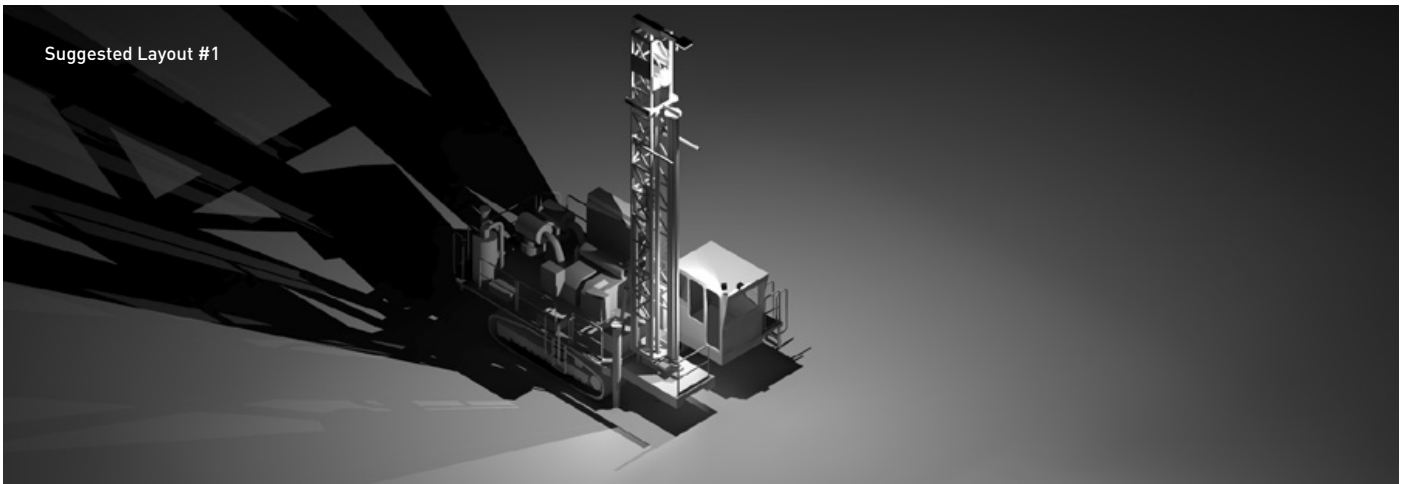

## SUGGESTED LAYOUT #2

Model No.	Luminaire	Optic Type	Quantity
CP56-L25-MPB-NPS	CP56 Flood Light	No Optics - 120° Beam Angle	2
CP9-M-XML-NOP-MPB-NPS	CP9 Flood Light	No Optics (120° Beam Angle)	1
CP9-M-XML-Q209-MPB-NPS	CP9 Flood Light	O209 - 40° x 18° Beam Angle	1

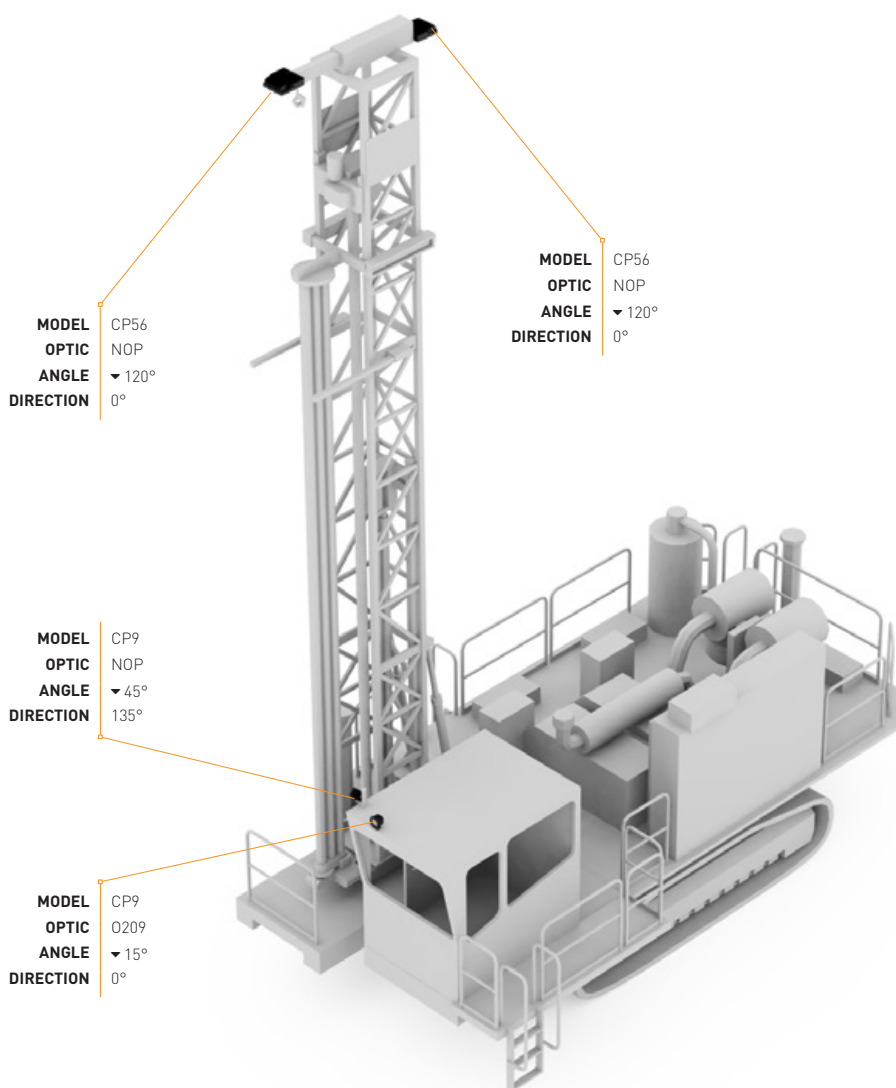

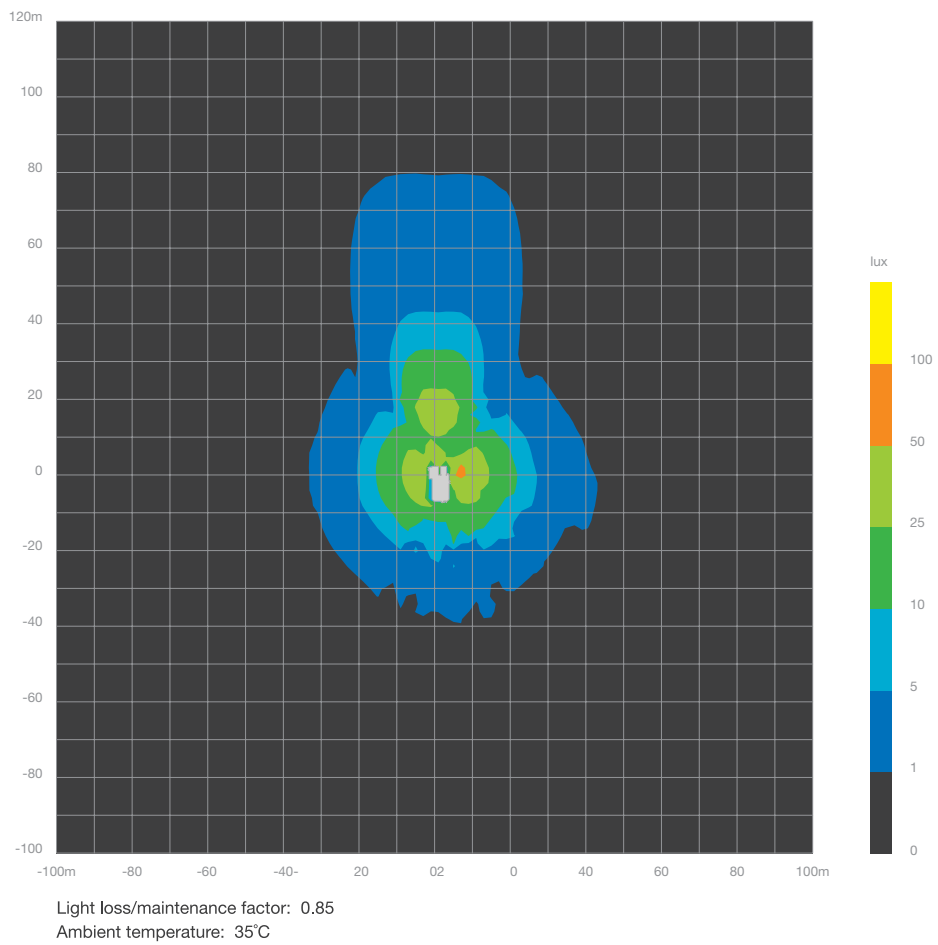
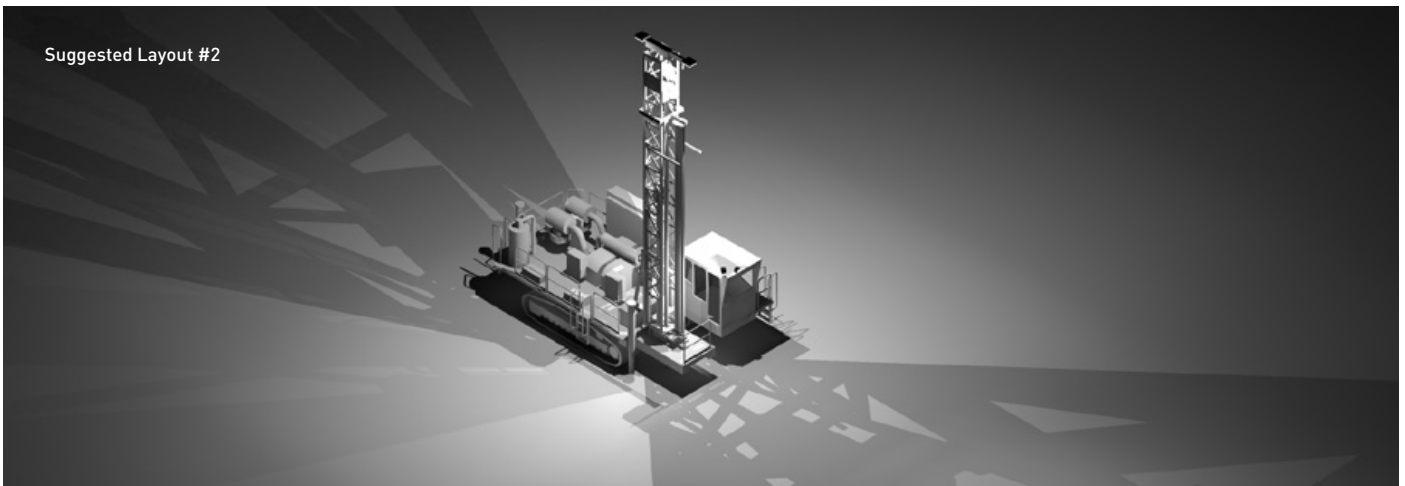

### SUGGESTED LAYOUT #3

Model No.	Luminaire	Optic Type	Quantity
CP56-L25-MPB-NPS	CP56 Flood Light	L25 - 50° Beam Angle	4
CP9-M-XML-NOP-MPB-NPS	CP9 Flood Light	No Optics (120° Beam Angle)	1
CP9-M-XML-O209-MPB-NPS	CP9 Flood Light	O209 - 40° x 18° Beam Angle	2

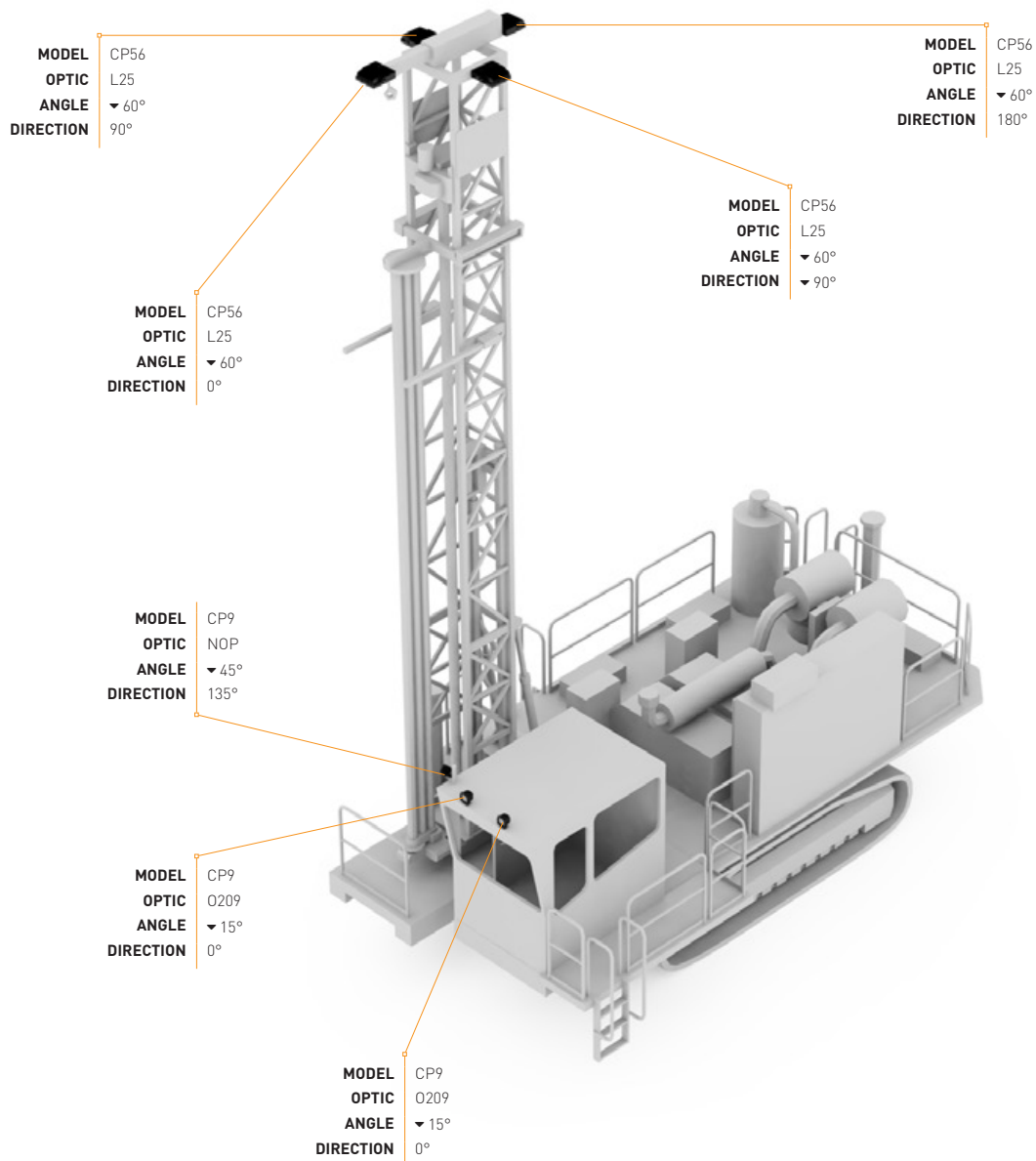

Suggested Layout #3

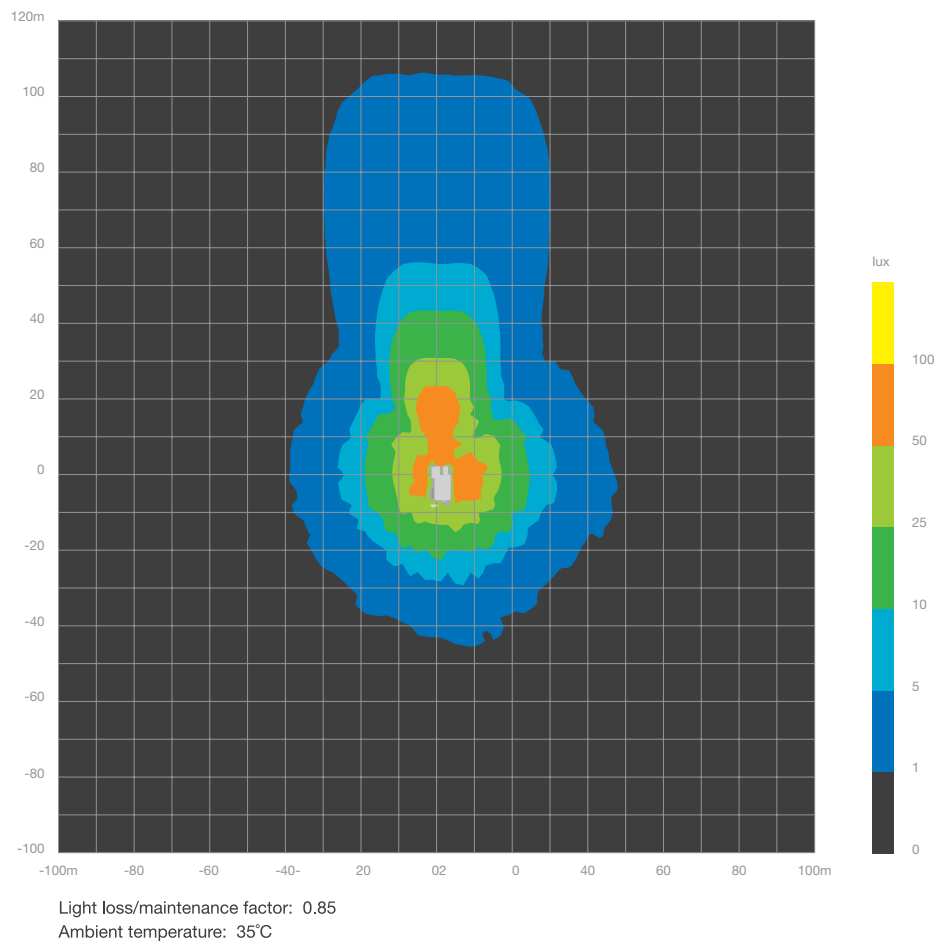
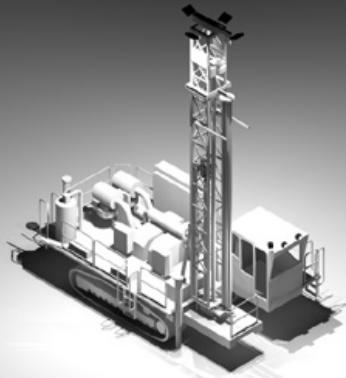



Simulated Result

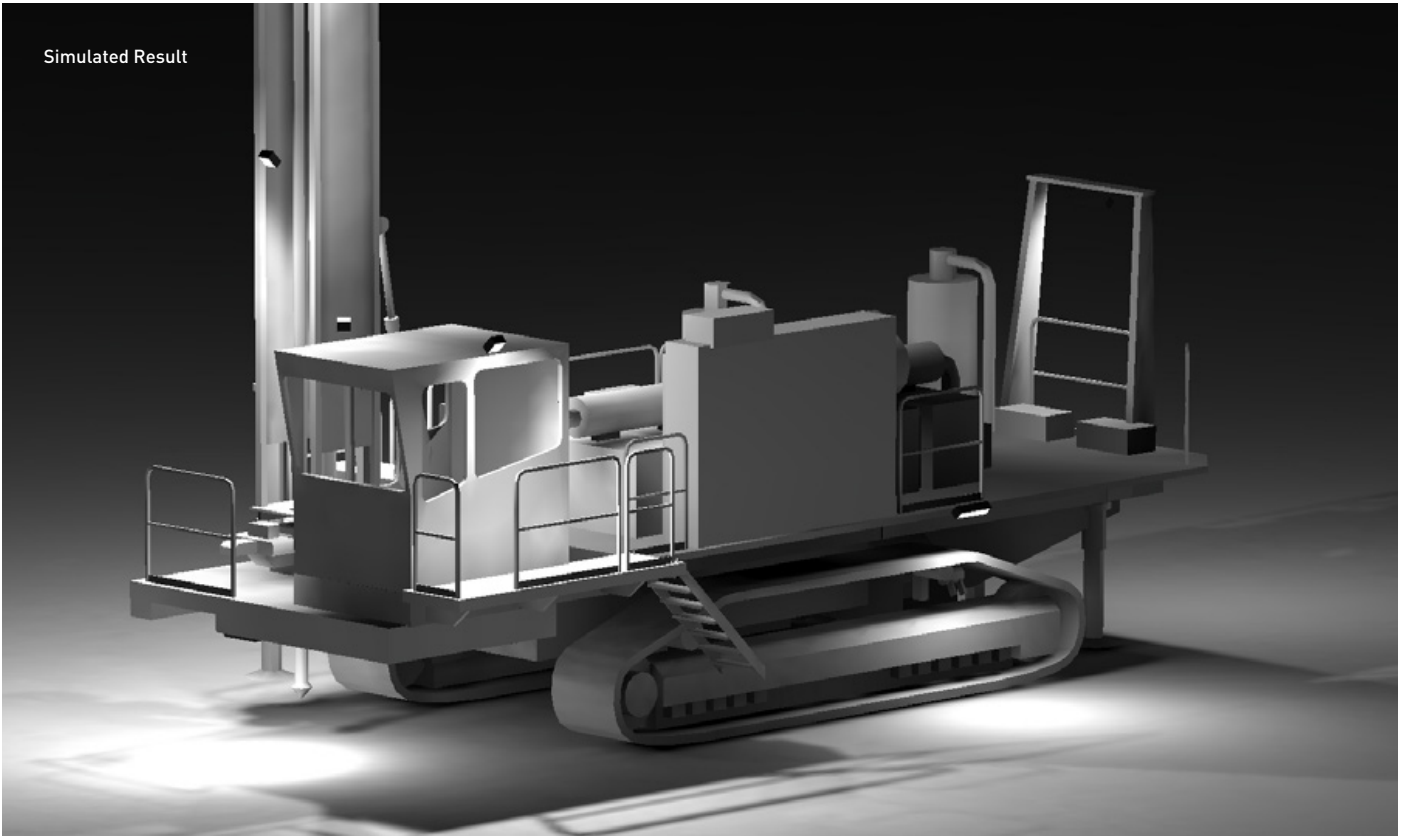

Simulated Result

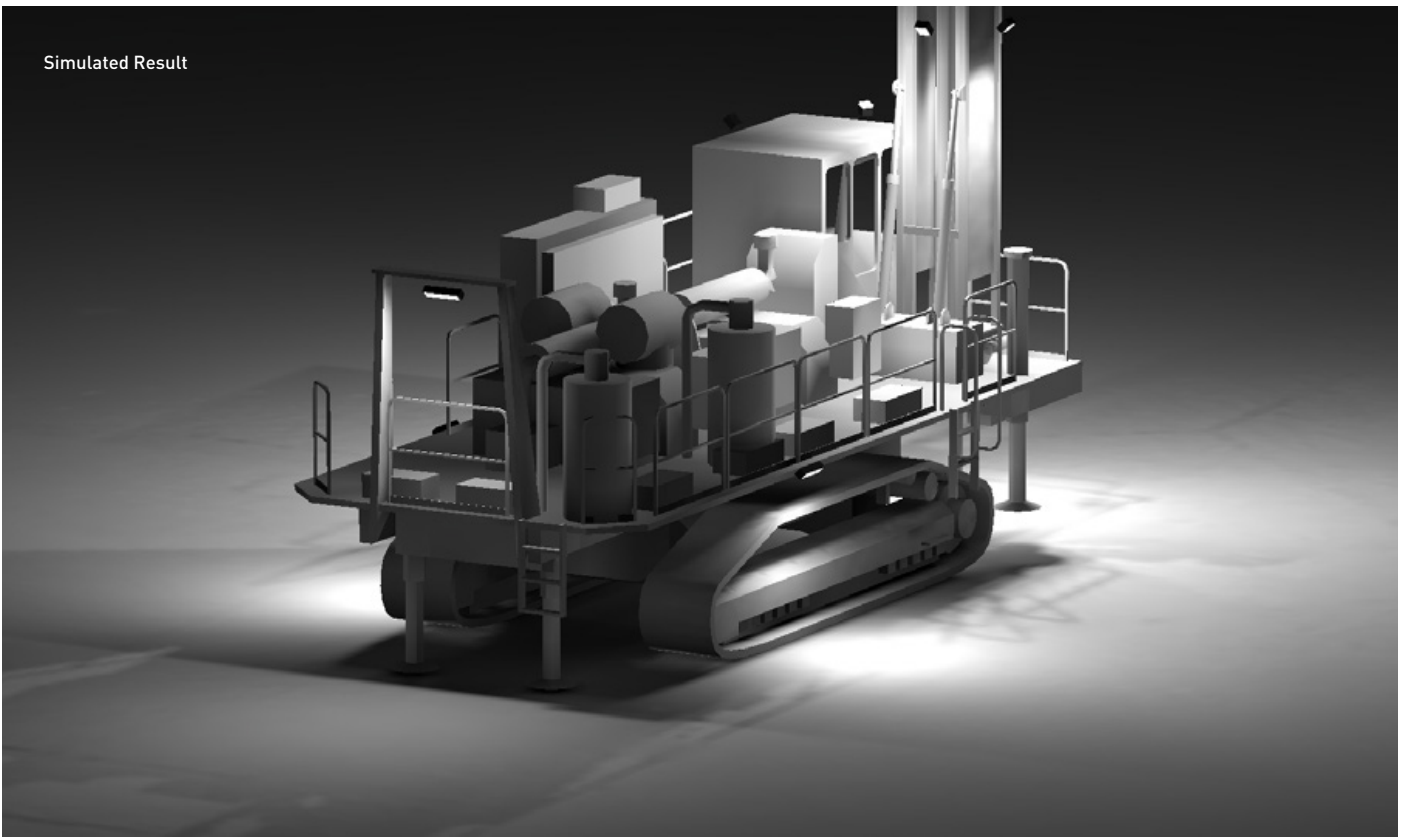

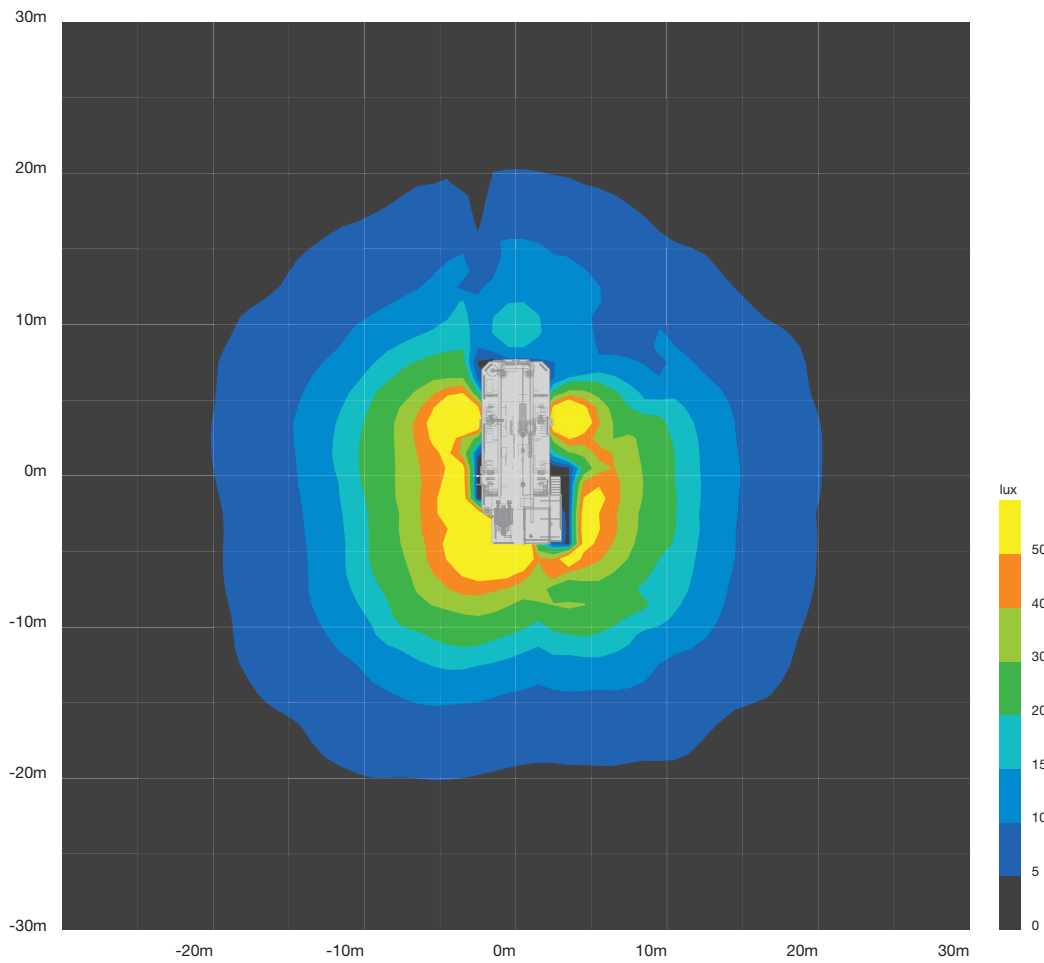

Light loss/maintenance factor: 0.85  
Ambient temperature: 35°C

VERTICAL ILLUMINANCE LEVELS (LUX)  
ALONG RAISED DRILL MAST

