

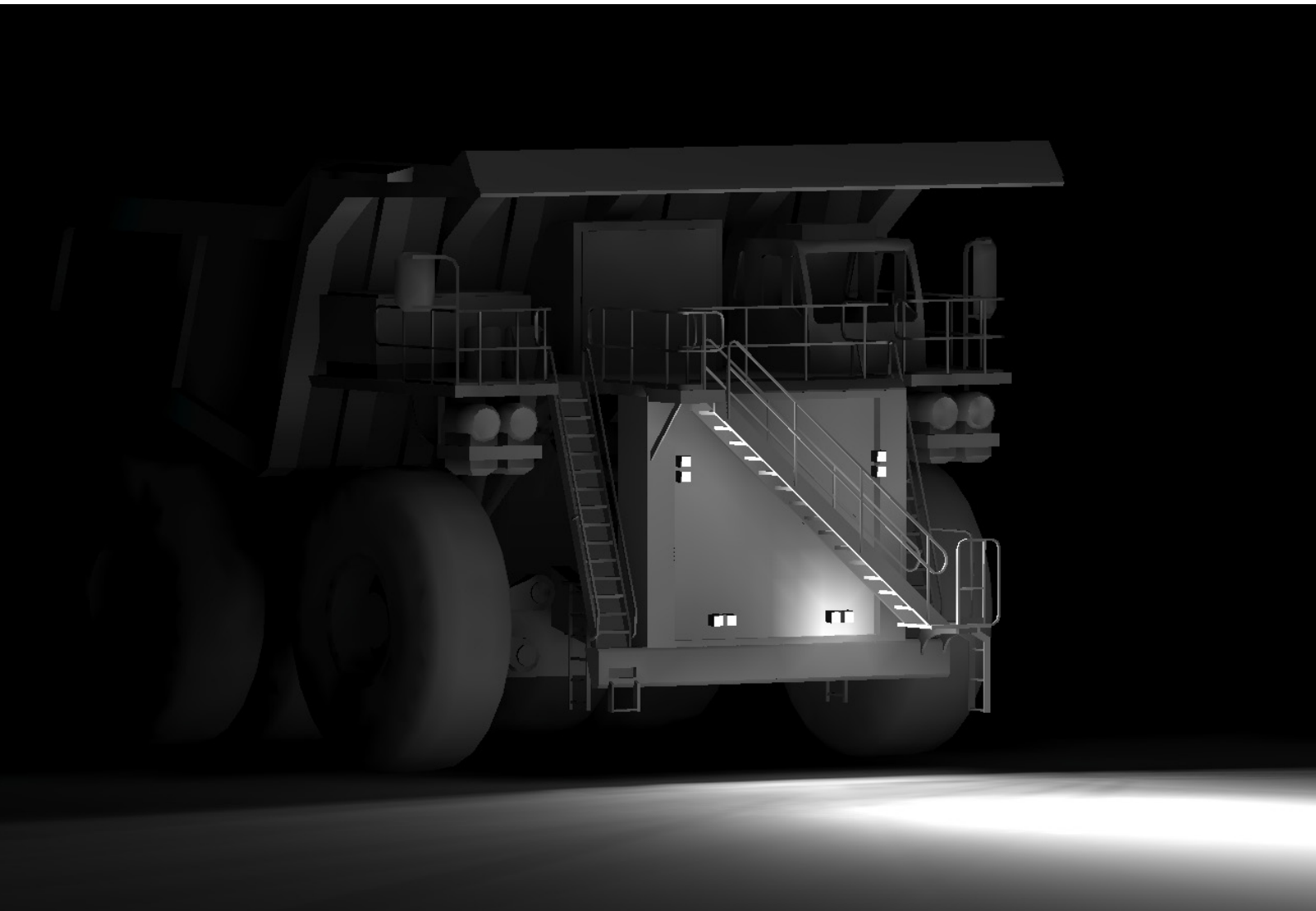

LIEBHERR

T282B

REPORTE DE DISEÑO DE ILUMINACIÓN Y SIMULACIÓN



Programación / diseño de la luminaria

Símbolo	Cantidad	Etiqueta	LFF	Descripciones
	4	CP9-XML-L07	0.850	Coolon CP9 LED w/ L07 Óptica, +/- 7° Ángulo de Haz
	4	CP9-XML-0209	0.850	Coolon CP9 LED w/ 0209 Óptica, +/-20°x9° Ángulo de Haz

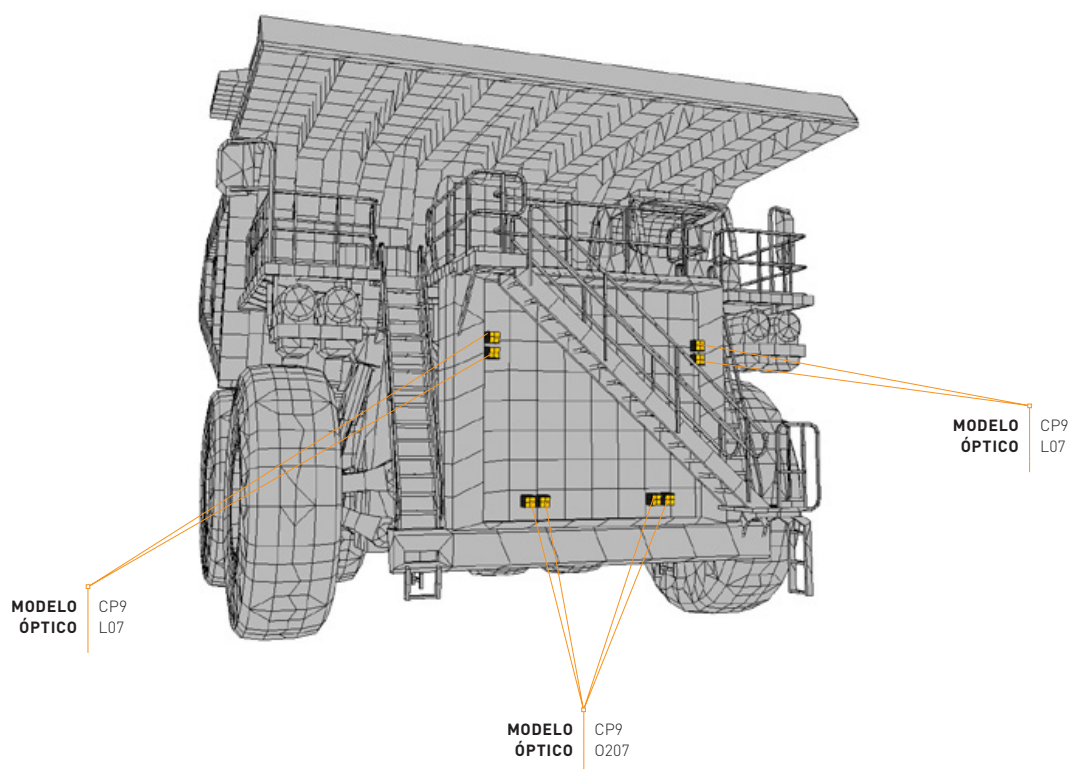

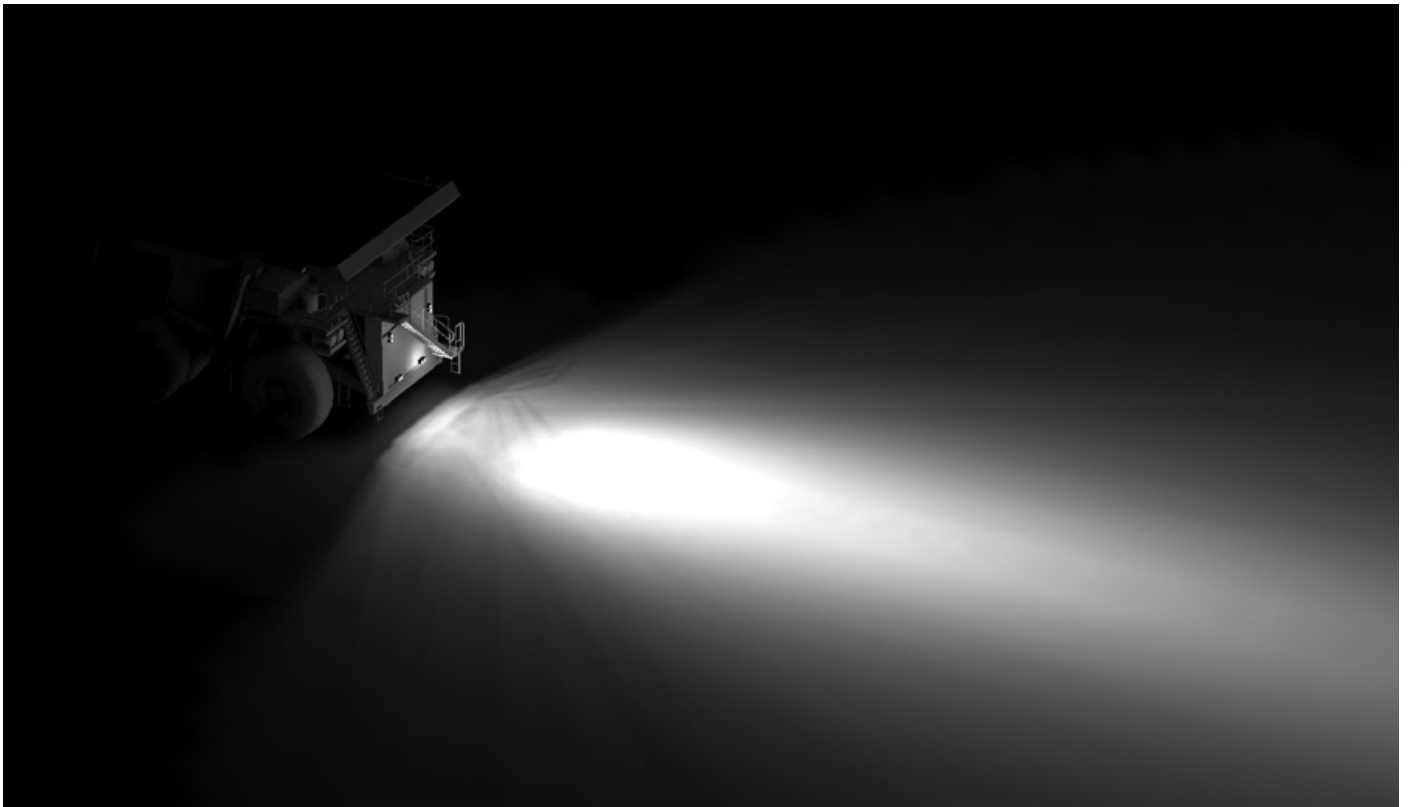

Programación / diseño de la luminaria

Símbolo	Cantidad	Etiqueta	LFF	Descripciones
	4	CP9-XML-L07	0.850	Coolon CP9 LED w/ L07 Óptica, +/- 7° Ángulo de Haz
	4	CP9-XML-0209	0.850	Coolon CP9 LED w/ 0209 Óptica, +/-20°x9° Ángulo de Haz



Programación / diseño de la luminaria

Símbolo	Cantidad	Etiqueta	LFF	Descripciones
	4	CP9-XML-L07	0.850	Coolon CP9 LED w/ L07 Óptica, +/- 7° Ángulo de Haz
	4	CP9-XML-0209	0.850	Coolon CP9 LED w/ 0209 Óptica, +/-20°x9° Ángulo de Haz



Programación / diseño de la luminaria

Símbolo	Cantidad	Etiqueta	LFF	Descripciones
	4	CP9-XML-L07	0.850	Coolon CP9 LED w/ L07 Óptica, +/- 7° Ángulo de Haz
	4	CP9-XML-0209	0.850	Coolon CP9 LED w/ 0209 Óptica, +/-20°x9° Ángulo de Haz

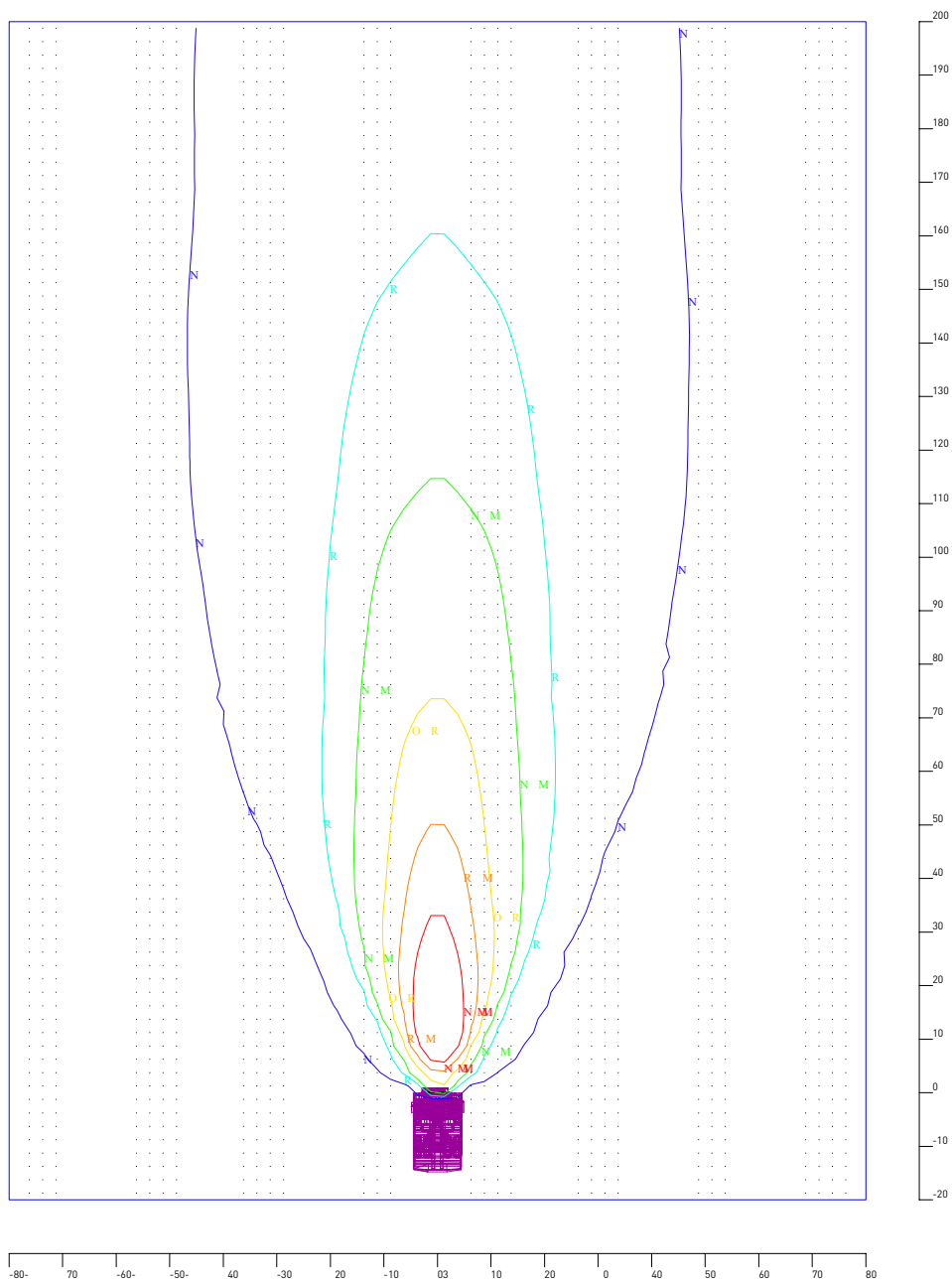

Programación / diseño de la luminaria

Símbolo	Cantidad	Etiqueta	LFF	Descripciones
	2	CP9-XML-0209	0.850	Coolon CP9 LED w/ 0209 Óptica, +/-20°x9° Ángulo de Haz

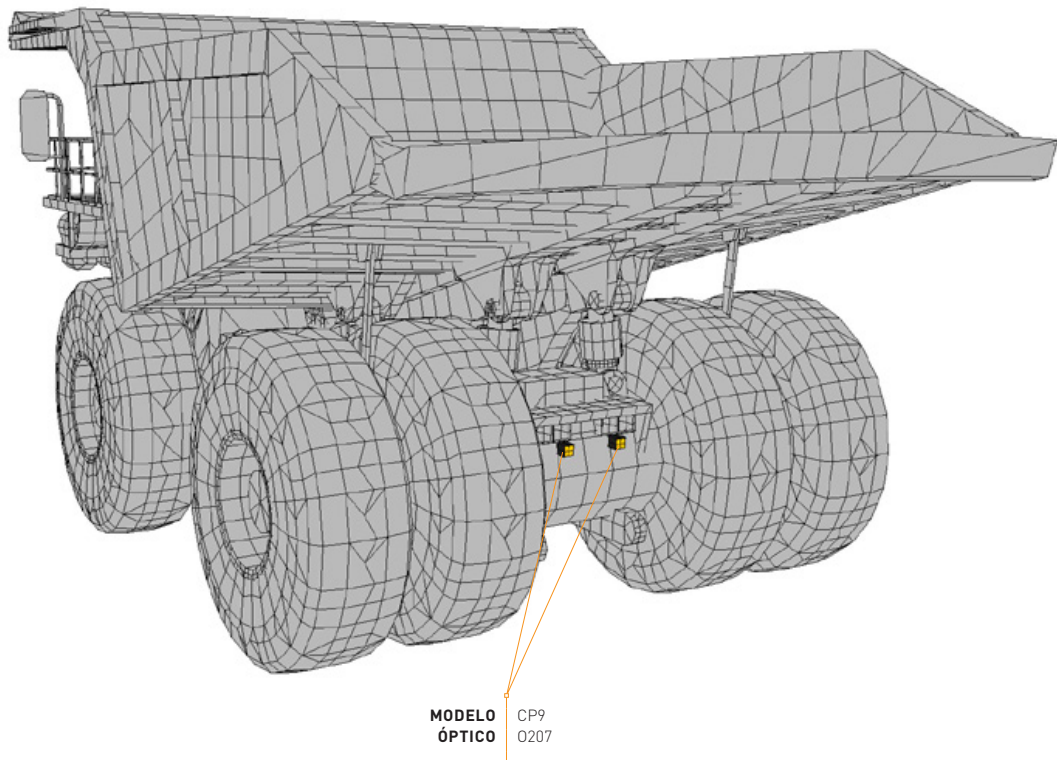

Programación / diseño de la luminaria

Símbolo	Cantidad	Etiqueta	LFF	Descripciones
	2	CP9-XML-0209	0.850	Coolon CP9 LED w/ 0209 Óptica, +/-20°x9° Ángulo de Haz

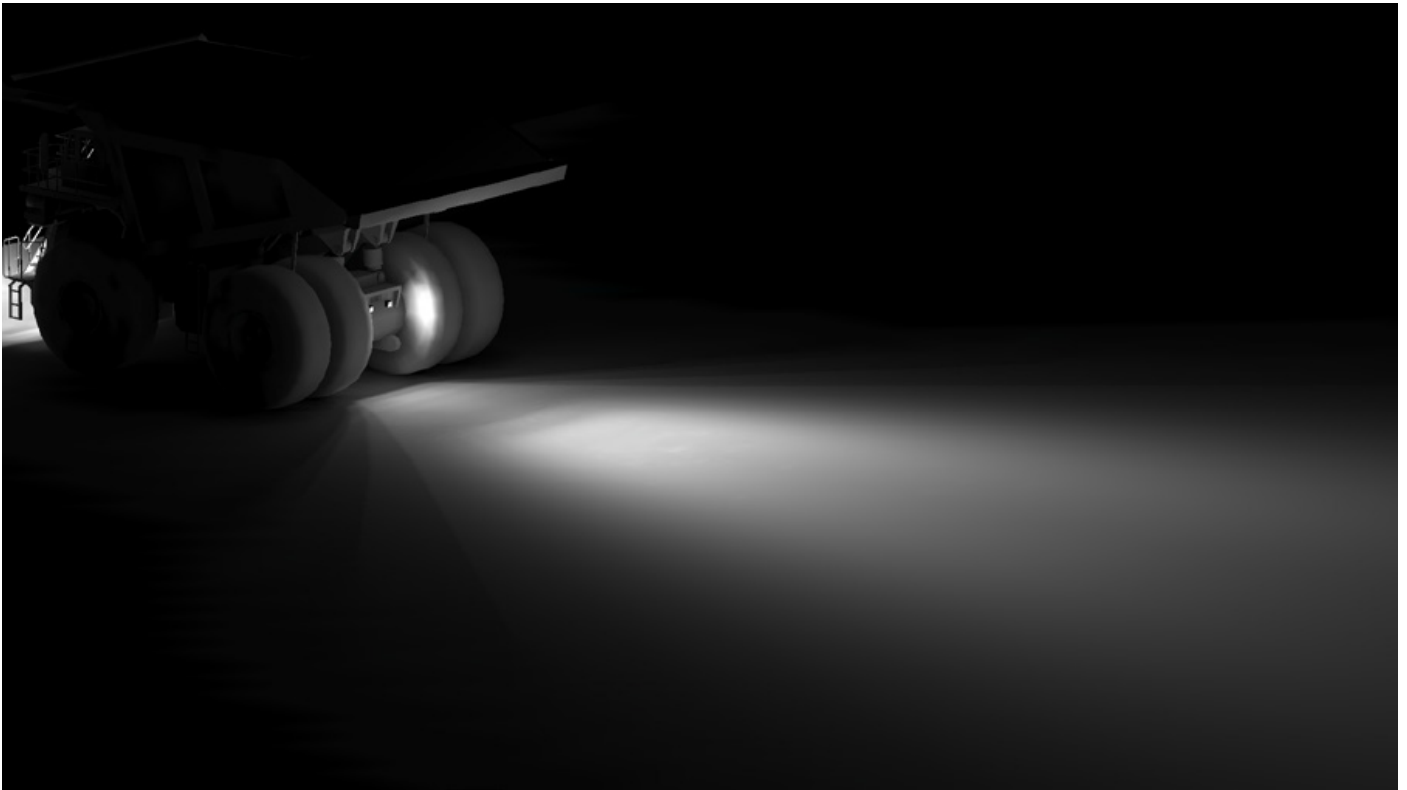

Programación / diseño de la luminaria

Símbolo	Cantidad	Etiqueta	LFF	Descripciones
	2	CP9-XML-0209	0.850	Coolon CP9 LED w/ 0209 Óptica, +/-20°x9° Ángulo de Haz

